

# Archaeology of College Hill: John Brown House

Results and Interpretations from the Fall 2009 Excavations

---

Krysta Ryzewski, Editor, with contributions from the students of ARCH1900, *The Archaeology of College Hill*, Joukowsky Institute for Archaeology and the Ancient World, Brown University

**ARCHAEOLOGICAL REPORT SUBMITTED TO**

John Brown House Museum, Rhode Island Historical Society, 2010

## TABLE OF CONTENTS

Acknowledgements	4
<b>CHAPTER 1 Introduction</b>	<b>5</b>
Krysta Ryzewski	
<b>CHAPTER 2 History of the John Brown House</b>	<b>6</b>
Alyssa Thelemaque	
<b>CHAPTER 3 Marsden Isael Perry: A Man of Excessive Taste</b>	<b>13</b>
Alexander Mittman	
<b>CHAPTER 4 Site-wide Stratigraphy Report</b>	<b>26</b>
Sarah Baker	
<b>CHAPTER 5 Unit 6 Excavation Summary</b>	<b>47</b>
Elise Merchant	
<b>CHAPTER 6 Unit 7 Excavation Summary</b>	<b>59</b>
Ben Colburn	
<b>CHAPTER 7 Unit 8 Excavation Summary</b>	<b>77</b>
Andrew Seiden	
<b>CHAPTER 8 Unit 9 and STP 3 Excavation Summary</b>	<b>88</b>
Michael Camarillo	
<b>CHAPTER 9 Landscape Archaeology of the John Brown House Property</b>	<b>100</b>
Julie Pridham	
<b>CHAPTER 10 Walking Tour; the Archaeological Landscape of the JBH</b>	<b>121</b>
Bridget Smith	

## CHAPTER 11 OBJECT BIOGRAPHIES

<b>SOLO-cup   Dime   Wire Nail</b>	<b>126</b>
Siham Abed	
<b>Pencil   Bottle Cap   Iron Spike</b>	<b>130</b>
Elise Merchant	
<b>Porcelain   Penny   Pipe Stem</b>	<b>137</b>
Laura Sammartino	
<b>Electrical Insulation   Whiteware   Drainpipe</b>	<b>144</b>
Bridget Smith	
<b>Porcelain Plate   Bellarmine Sherd   Wire Nail with Star Design</b>	<b>152</b>
Sarah Roberts	
<b>White-ware Sherd   Pipe Saddle   Pendant</b>	<b>158</b>
Alexander Mittman	
<b>Canton Porcelain Fragment   Plastic Coffee Cup Lid Fragments   Angle Iron</b>	<b>165</b>
Alyssa Thelemaque	
<b>Gimlet Point Screw } Polychrome Overglaze Chinese Porcelain   Anthracite Coal</b>	<b>172</b>
Michael Camarillo	
<b>Canton Porcelain   Brown Lead-Glazed Redware   Terra Cotta Drainpipe Segment</b>	<b>181</b>
Andrew Seiden	
<b>Cantonware Porcelan   Pipe Stem   Copper Nail/Tack</b>	<b>188</b>
Sarah Baker	
<b>Red Enamel Painted Porcelain Sherd   English Porcelain   Green-glazed Redware</b>	<b>194</b>
Ben Colburn	

## **ACKNOWLEDGEMENTS**

We are especially grateful to the staff of the John Brown House Museum and the Rhode Island Historical Society for their continued support of this work, and for donating their time to help students with their research projects, especially Kirsten Hammerstrom, Dan Santos, Morgan Grefe, Dalila Goulart, and Bernard Fishman. The class ran smoothly thanks, in large part, to the assistance provided by TAs Alex Knodell and Elise Nuding. Special thanks to the Joukowsky Institute of Archaeology and the Ancient World at Brown for encouraging this work, the John Nicholas Brown Center for Public Humanities and Cultural Heritage for storage space, the RIHPHC for their consultation, and, most of all, to the students of ARCH1900, whose enthusiasm for archaeology made this project a success.



## CHAPTER 1 Introduction: Excavations at the John Brown House, 2009

Krysta Ryzewski

Offered as an advanced undergraduate course in the Joukowsky Institute for Archaeology and the Ancient World at Brown University, the *Archaeology of College Hill* (ARCH01900) is a hands-on introduction to archaeological survey, excavation, and preservation offered annually during the fall semester. In 2009 the course was held for the second time at the John Brown House on the corner of Benefit and Power Streets on the East Side of Providence. The John Brown House is a historic museum that is owned and operated by the Rhode Island Historical Society (RIHS). The proximity and interaction between the museum, preservationists from the RIHS, and the College Hill students conducting archaeological fieldwork was especially effective for communicating the broad scope of the archaeological process to the students, from the ground up. The course met for three hours once a week between September and December of 2009. The semester schedule permitted a total of eleven days of excavation and three days of labwork following the outdoor fieldwork. Over the course of ten weeks, the students excavated four units of varying sizes (1x2m, 2x2m, and 1x1m), and completed one 50x50cm shovel test pit in the area scheduled for impact during the subsequent construction of a geothermal well on the lawn adjacent to the northwest corner of the house. Information about the site layout and excavation methodology are detailed in several of the following chapters, and in the 2008 Archaeological Report (available at <http://proteus.brown.edu/archaeologyofcollegehill/Home>).

As part of the course requirements, students maintained a wiki, an editable website, on which they posted a variety of formal and informal updates on a weekly bases (<http://proteus.brown.edu/archaeologyofcollegehill/Home>). At the end of the semester, students submitted independent reports based on different aspects of the excavations, the landscape's histories, and the artifacts collected. This report is a compilation of these student research projects; editorial changes have been kept to a minimum, in an effort to foreground the students' accomplishments. The first ten chapters include research on the property's historical background, analyses of the archaeological deposits in the excavation units, and interpretive approaches designed to integrate the findings and communicate them to a broader, non-academic audience. Chapter 11 is a collection of the second component of the students' research projects, object biographies, which involved contextual analyses of three unique artifacts from the excavation assemblage by each student. It is our hope that the findings, as presented here, will be a useful resource for historians, archaeologists, students, and other interested members of the community.

## CHAPTER 2 History of the John Brown House

Alyssa Thelemaque

This chapter focuses on the structural history of the John Brown House. I will be doing this by looking at the architectural structure and interior decorations of the original house as well as the major additions and renovations made to the house throughout the years by its various owners<sup>1</sup>. I also want to briefly explore the personal histories of the various owners of the house. Since the construction of the house was conceived by, and is still referred to by his name, I will specifically focus on John Brown and his extensive (and often confusing) family tree—rather than focusing too much on the history of Marsden Perry (see Chapter 3).

Before turning to the history of the ownership of the house, I think it's important to have a decent understanding of the John Brown family tree. A lot of the family members have similar names and close blood relationships (first cousins did get married), so I'd like to explain the relationship behind the names that I will be referencing later in the paper<sup>2</sup>.

John Brown was born to Captain James Brown (1698-1739) and Hope Power Brown (1702-1792) on January 27, 1736<sup>i</sup>. Captain James Brown also had a brother named Obadiah (1712-1762) who proved to be a major influence to his brother's sons in the adult life. John Brown had 3 older brothers James, Nicholas (1729-1791) and Joseph (1733-1785), a sister named Mary, and a younger brother named Moses (1738-1836). While the eldest brother James died relatively early in comparison to his other brother's, the four remaining brothers were able to lead successful lives.

Shortly after the death of their eldest brother, John, Nicholas, Joseph and Moses—affectionately dubbed the Four Brothers: Nick and Josie, John and Mosie<sup>ii</sup>—began what would be lucrative and influential business careers. Their uncle Obadiah Brown had entered into the mercantile industry in 1730, and in 1751<sup>3</sup>, the youngest brother Moses began working as a clerk for his uncle. The two men formed a close relationship, especially in terms of business dealings, and entered into a business partnership in 1754. Eventually, the remaining three brothers joined the firm as well, and the Brown family established themselves as respectable, formidable businessmen. When Obadiah passed away in

---

<sup>1</sup> In terms of sources used, the information regarding architectural changes and ownership changes came from the black informational binder currently located at the John Brown House museum. Also, rather than make a citation for every instance in which a fact was taken from another source, topical paragraphs are simply attributed to the source in which the grouping of information was taken from. In instances where non-dated facts are included, logical deductions were used to decide what changes were made to the house and when. For example, if it's known that the original house was only rectangular shape, but the house already had the 3-story "l-shaped" addition when purchased by Perry, it must have been an owner in between John Brown and Marsden Perry who made the addition since the change was not attributed to either of the men.

<sup>2</sup> (See Image 1 for the pictorial version of the family tree)

<sup>3</sup> When obtaining dates for the various events in the Brown family history, different sources provided different dates for the same events. In those instances, the date that was cited the most often was chosen to be used in this paper.

1962, the four brothers, headed by Nicholas, formed Nicholas Brown and Co. The company formed the Hope Furnace, a profitable iron foundry, in 1765, was involved in the manufacturing of spermaceti candles and participated in extensive overseas trading<sup>iii</sup>.

When Nicholas Brown and Co. chose to stop their involvement in the slave trade in 1765 following a disastrous slave ship voyage, John Brown grew dissatisfied with the company. John Brown officially withdrew from the company in 1772 and Moses and Joseph withdrew from the company as well in 1774. John Brown formed his own company with Tench Francis and his son John Francis in 1781 and called it Brown & Francis Co. The formation of his own company marked the beginning of a truly remarkable business career. One of Brown & Francis Co.'s notable achievements was their first trip to the Orient, South China to be specific, in 1787 where they traded in many Chinese imports—imports that would even be featured in John Brown's own home.

A man of imposing physical size as well as a man with an imposing personality, John Brown had many other notable achievements outside of his immediate business dealing. In 1772, he participated (and is even credited with leading) the colonial attack on and burning of the British trade ship the *Gaspee*. John Brown was also an ardent supporter of the American Revolution, a U.S. Congressman in 1799, and even a treasurer at Brown University<sup>iv</sup>.

Brown also had a rewarding family life. John Brown married Sarah Smith (1738-1825) in 1760 and together, the couple had 6 children. Their children were Benjamin, James IV (1761-1834), Abigail, another Abigail (1766-1821), Sarah (1773-1846), and Alice, but sadly, Benjamin and Abigail died in infancy. The other children were able to lead productive lives, and although James IV never married—John Brown never stopped prodding his son to end his bachelor lifestyle—Abigail married John Francis, Alice married James Brown Mason and Sarah married Charles Frederick Herreshoff.

While the direct descendants of John Brown would play an obvious role in the history of the house, John Brown's brother Nicholas also fathered a family tree that had a key role in the history of the house. Nicholas Brown married Rhoda Jenckes and together they had Hope Brown (1763-1767) and Nicholas Brown Jr. (1769-1841). Their daughter Hope married Thomas Poynton Ives while their son Nicholas Jr. married Anne Carter. Later in this paper, it will be important to remember that Hope and Thomas had two sons, Moses Brown Ives and Robert Hale Ives. Robert Hale Ives had a daughter named Elizabeth Amory and she married William Chase Gammell and had two daughters with him. Nicholas Jr. and Anne Carter had a son, John Carter Brown, one of whose sons, John Nicholas Brown had a John Nicholas Brown Jr.<sup>v</sup>. Confusing? Most definitely. But understanding the family tree, even if only in a small amount, will make understanding the timeline of the John Brown House ownership much easier.

The remaining part of this paper will focus on the John Brown House itself and its immediate surrounding landscape features. John Brown purchased the tract of land which houses the John Brown House from his brother Nicholas in 1769. The estate as it was originally purchased included the entire

area as bounded on the west by Benefit Street, Charlesfield Street on the North, Power Street on the South, and Brown Street on the East. It wasn't until 1786 that John Brown had construction of his actual home begun<sup>vi</sup>.

Building the home was a long process that took almost two years. The home was partially designed by Joseph Brown, but also John Brown himself and John Francis. Brown wanted his home to combine elements of the (then) new Early Adams Style and the more "outdated" Georgian style<sup>vii</sup>. Combined, the styles recalled to mind stately English homes, but the decoration scheme was greatly influenced by French aesthetic. Payment records indicate that the house was constructed by skilled Northeastern craftsmen of European, African, or Native-American descent. Although the exact ethnicity of the workers is unsure, records do show that at least two African-Americans worked on the construction of the home<sup>viii</sup>. Although not necessarily related to the history of the house, it is interesting to note how Brown's involvement in the slave trade served to benefit him even in his domestic sphere. At the time of its construction, the John Brown House was the largest house in Providence. In keeping with the theme of "display my wealth and expensive taste," the house was situated on what was at the time, a large hill that both had a wonderful view of the waterfront that used to reach very close to the house and also was in a prominent place in order to be seen and admired. It was designed with lavish entertainment in mind, and the house-warming party was actually Sarah Brown's wedding party. That being said, the family officially moved into the home in 1788, and although not being completely finished, the Brown family set about enjoying life in their admired mansion.

The original house was almost rectangular in shape. The original house is said to have been 54 x 60 feet although in his will, John Brown describes the house as being 54 x 60 feet. The house was originally in the exact center of the green yard (which we still see today) and the garden (which has been encroached upon in terms of size). The entrance gate stood back from the street at the top of a flight of brownstone steps. A visitor, after making the short trek up the impressive stairs, would have seen the carriage gate on his right side that led to the "paved yard" or the impressive front of the house with its Palladian window and brownstone columned porch crowned by an intricate wooden entablature and balustrade<sup>4</sup>.

The house was three-stories high with an attic and a deep basement underneath the entire house. Inside, there would have been a long central entryway running through the house with masonry partitions on each side—John Brown prided himself on the fact that almost every wall was constructed entirely of brick. The flooring was a greenish-yellow soft pine flooring and the walls were all papered in late 18<sup>th</sup> century designs reproduced from Parisian hand-blocks. There would have been four rooms, each with a fireplace. I personally find it interesting that although there were four fireplaces, there were

---

<sup>4</sup> The twisted balustrade, a characteristic of local architectural trends, would have indicated a local Providence carpenter.

only 2 chimneys—one chimney on the east side and one chimney on the west side. The rooms on the first floor would have been used for dining and formal entertainment, and included a library and a parlor.

For decoration, engaged columns were built into the wall, and imported French marble busts—some from the French town of Versailles—were placed atop. Instead of window curtains or draperies, shutters were used to shut out light and retain warmth. Although there are many oil paintings featured in the John Brown House Museum, only three of the oil paintings would have belonged to him. It is more likely that the walls were decorated simply with the colorful wallpaper as well as more freestanding decorations such as marble busts. There were of course other decorations, small details, and expensive furniture pieces that would have been strategically placed in order to continue the impressive aura that would have been created by the house.

One of the most impressive features of the house that still remains today is the beautiful staircase that links all three floors. The staircase features intricately carved newels and handrails with various designs. This exquisite mahogany masterpiece was, when paired with the unobstructed view upon entry from the front of the house to the back of the house, an eye-catching addition that was meant to draw admiration and praise from those who visited the house.

The second and third floors were almost identical in construction to the first floor, but the rooms would have been employed differently. The rooms in the second floor would have been used for adult bedchambers—also places for the informal entertainment of close family friends—and the guest bedrooms. The rooms in the third floor would have been used for the children’s bedrooms and any overflow rooming or storage that was needed.

The landscape of the house would have looked very different from what is seen today. John Brown mentions various “outhouses” that would have been placed throughout the yard. Directly behind the original house, there were 3 connected buildings. From west to east, those buildings were the following: a 2-story summer kitchen, a wood house, and a carriage house. Brown also references a stable house, a wood house, a bath house, a house for the servant’s quarters, and a well, as well as various bays<sup>ix</sup>. The outside itself would have been decorated as well, possibly with more busts brought back from John Francis’ 1792 trip to Versailles.

Today, and especially at the time of its original construction, the John Brown House served as a testament to the wealth and influence of John Brown. The house was admired by those who were lucky enough to be invited inside as well as those who were simply passer-bys.

Tuesday 27<sup>th</sup>: This morning walked out to see the most elegant building in America, built by John Brown. It is situated on a very high hill and commands a prospect of the town and country for many miles with a delightful view of the river. The house is very

large and furnished in a most extravagant manner. 'Tis built after a plan of some of the Nobleman's Seats in England and far surpasses any I have seen<sup>x</sup>.

When John Brown passed away in 1803, he left the house and the 1 ½ acres of land to his wife Sarah. Upon her death, he stated in his will that the house should then be left to his son James IV. Sarah Smith Brown occupied the house until her death in 1825 when the house, and the remainder of the John Brown estate, was officially left to the remaining unmarried child, James IV.

When James took possession of the estate, he began dividing up the property, and for a short period, the house property underwent a series of quick changes in ownership. On December 7, 1831, he sold the land west of the homestead (the yard area from the west of the house extending to Benefit Street) to Robert Hale Ives. After James IV died in 1834, his estate was further divided. On April 21, 1835, Sarah Brown Herreshoff was officially deeded the house, the furniture, and the land extending east of the house to Brown Street. James IV's nephew John Brown Francis received the 3-acre lot at the "eastmost of Power Lane<sup>xi</sup>."

Sarah Herreshoff left the house relatively unchanged and occupied it until her death in 1846. Upon her death, she officially left the home to her grandson James Brown Herreshoff with the provision that her daughters Ann, Sarah, and Agnes be allowed to occupy the home. On October 26, 1852, Sarah Herreshoff's descendants deeded the home to Hope Brown Ives. On February 21, 1852, Hope Brown Ives divided her newly needed property between her two sons, Robert Hale and Moses Brown. Robert received the remainder of the western side (including the house), while Moses received the land east of the house. In 1854, Robert Hale Ives presented the John Brown House to his Elizabeth Amory as a present to commemorate her marriage to William Gammell. When he died in 1875, he left the remainder of his estate to his daughter. This estate included not only the original John Brown House, but also the Hale Ives House that he had constructed around 1857<sup>5</sup>.

After John Brown, Elizabeth Amory Ives Gammell was the next owner of the house to make major renovations. While the house was in her possession, the Victorian era and its trends were very influential on popular culture. Therefore, many of the changes she made to the home were indicative of the Victorian style that was en vogue at the time. Her main addition to the home was the three-story "L-shaped" addition to the back of the home. This addition was used for servant's quarters and meant to put the servant's in closer proximity to the family. It's also worth noting that this addition connected the house to what used to be the outbuildings<sup>6</sup>.

---

<sup>5</sup> The Hale Ives House would have been located where the ARCH 1900 Archaeology of College Hill class had their Unit 6 digging site.

<sup>6</sup> This can be better seen in the fact that what is displayed in the John Brown House Museum as the "carriage house" used to be the wood shed. Upon original construction, the wood shed was intentionally set apart from the house.

The Victorian style incorporated rich colors and fabrics. It's plausible to imagine the house, as decorated by Elizabeth Gammell, with deep, jewel-toned damasks and velvets, flowery wallpapers, plush and beautiful rugs, as well as touches of glass and other ornate objects for further decoration. It was along this decorative scheme that Elizabeth Gammell added the beautiful iron staircase with a glass treaded surface. This addition was both fashionable and practical (it was said that she had the glass staircase added so that the maids would be able to travel between floors without making too much noise on a creaking wooden staircase<sup>xii</sup>). One feature of the house that was lost after her additions was one of the Venetian windows on the second floor. At the entrance of the house, the visitor can see, above the main door, a beautiful Palladian window with a small balcony. This was a feature that would have been mirrored on the other end of the 2<sup>nd</sup> story hallway. Unfortunately, when Elizabeth Gammell made her renovations to the home, this feature of the home was lost.

Elizabeth Amory Ives Gammell occupied the house until her death in 1897 when she left the John Brown House to her two daughters, Harriett and Helen. Since her father Robert Hale Ives and only left the yard area, including his house, to the Gammell family as long as Elizabeth and William were alive, the Hale Ives returned to the possession of the Hale-Ives family. In terms of the John Brown House, the two Gammell daughters spent the majority of their time either residing in Newport or traveling to Europe, so they put the house up for sale. The estate (the John Brown House and the western yard) was purchased by Marsden J. Perry on October 15, 1901. The major changes made to the house by Perry consisted of his interior renovations and his landscaping of the exterior.

In terms of the outside of the house, Perry didn't make too many changes at first. The Hale Ives was continuously occupied by Robert Ives Gammell until 1915. When the house began to only be inhabited sporadically, Robert Ives Gammell's wife sold the yard area to Perry. Perry then decided to completely destroy the home at some point between 1923 and 1926. The reason for why exactly he decided to destroy what had been a beautifully impressive home is unknown, but he did landscape the resulting exterior into the format that is seen today (minus the parking lot).

Perry's changes within the home involved a lot of technological updates and changes made to bring the home into the newer era. He first made changes to the main entryway. Although it's unsure what changes he made exactly, his new entryway was described as being "entirely modern<sup>xiii</sup>." He added molded plaster ceilings in the first floor eastern rooms and painted the northeast library with plaster and added ornate stucco onto the walls. He also added door hardware and decorations to the doorways throughout the home and changed the original soft pine floor to a more refined Carolina pine wood flooring. He enlarged the pantry and completely changed the now-indoor kitchen.

Another one of his major structural changes involved the northwestern dining room. Originally, the northwest and southwest rooms each had closets that were used for hanging coats and as storage space for the children's toys. In the northwest dining room, there would have been some sort of

southern wall near what is today's functionless door that faces the west green yard. It appears that Perry removed the south wall, blocked up the door way, and removed the servant's staircase that led from said doorway to the upper floors. He did this to enlarge the dining room and better accommodate his large dinner parties.

His other changes involved technological updates. He updated the basement to make it into a laundry facility, wine cellar and a heating facility. That being said, Perry also installed central heating, and this is seen by the movable marble heating vents seen in many of the rooms today. He also wired the house with electricity and installed two functioning elevators. Perry also outfitted the house with indoor plumbing and he created beautiful bathrooms with Italian tiles, inset tubs, porcelain toilets, sinks, and ribcage showers.

In terms of decoration, Perry definitely added his masculine touch to the house. The hallway walls, and possibly other rooms, were covered in dark green, gilded leather hangings. While this might have made the house seem dark and ominous, the gilded touches subtly added a rich, ornamental feel to the home. Perry also decorated with Chippendale gilt mirrors and added deep mahogany panels to things like the doorways. His house was known for containing a notable collection of 18<sup>th</sup> century English furniture.

Perry passed away in 1935, and since the Great Depression had affected Perry more than he cared to admit, his widow sold the house to John Nicholas Brown in 1935 to pay off her debts. In 1942, John Nicholas Brown donated the home to the Rhode Island Historical Society. Following a series of renovations intended to restore the house as much to its original structure as possible, the Rhode Island Historical Society turned the home into the house museum that is available to the public today. There were also architectural changes that aren't easily accredited to a specific owner of the house. Since building permits, fire codes, and tax records weren't as specific or standardized as they are today, it's hard to find exact documentation of who made what renovations to the house. Some of these undocumented changes include a marble fireplace in what is currently displayed as the "music room", decorative moldings and arched entrance ways. Although it's hard to attribute these changes to a specific date, it is fairly safe to say that those weren't the types of things included in the original design of the house as done by John Brown.

The John Brown House is a fantastic piece of architecture. Not only can it be heralded as a beautiful house by even today's standards, it truly serves to personify Rhode Island as seen through the eyes of one of its influential patrons, John Brown. Despite the major changes made to the home's structure and the shrinking of the actual estate's boundaries throughout the years, it still stands as a testament to the John Brown family legacy and the longevity and beauty of colonial architecture.



### CHAPTER 3 Marsden Jaseal Perry: A Man of Excessive Taste

Alexander Mittman

Marsden Jaseal Perry was born on November 2, 1850 in Rehoboth, Massachusetts to an impressive family lineage.<sup>7</sup> One of his ancestors, Richard Perry, was a grantee of the Massachusetts Bay Colony a century before, and Marsden must have noted this fact well.<sup>8</sup> Marsden Perry took great pride in his family's heritage; his family crest, whether true or mistaken for another's, takes pride of place on his old player's piano, "Perry" simply carved beneath it. As the son of a farmer, he did not have many material possessions as a child nor much of an education, having left home at the age of 12 and homeschooled for most of his life before that.<sup>9</sup>

After he had begun to earn his millions, a decade or so later, he developed an obsession for collecting, especially fine Colonial pieces. He owned two Colonial mansions in his lifetime, one at 2 George Street, and the other at 52 Power Street, the property now known as the John Brown House.<sup>10</sup> His other passion was Shakespeare, one he apparently developed while still a child, sneaking a hidden copy of Shakespeare's Collected Works from his grandmother's library to read in his bedroom, nights.<sup>11</sup> Years later, his great love fizzled out suddenly when he lost the Devonshire Collection during an auction and was heard to say, "If I can't have the Devonshires... I will give up collecting. I will not take second place."<sup>12</sup> It was this fierce competitive spirit that would come to define him and his choices in acquiring his copious collections.

Coming from such a humble background, Perry, as many other *nouveaux riches*, felt the need to prove himself before the more distinguished millionaires who came from old money. But, for the most part the Providence elite spurned his efforts and in some cases sabotaged his business interests and political power.<sup>13</sup> However, I believe, many of his efforts in collecting – as well as his acquisition of the John Brown House and many of his structural changes to it, including his destruction of the Hale Ives homestead – can be traced to this fundamental desire to impress high society with what he thought of as good taste, more specifically, Georgian, or Colonial taste (the oldest money there is, when discussing America).

---

<sup>7</sup> Marsden Jaseal [sic] Perry, 2004, 11/29/2009 <<http://www.redwoodlibrary.org/notables/perry.htm>>.

<sup>8</sup> James G. McManaway, "Marsden Jaseal Perry," *Grolier 75*, ed. Alexander e. a. Davidson (New York: The Grolier Club, 1959) p. 61.

<sup>9</sup> *ibid.*

<sup>10</sup> Dan Santos, ed. Alex Mittman.

<sup>11</sup> Raymond Broadhurst, *Marsden J. Perry and others (manuscript at RIHS Library)*.

<sup>12</sup> Marsden Jaseal [sic] Perry

<sup>13</sup> See Eugene V. Blanchard, et al, *Brown University honors theses, 1964, 1964*).

## **A History of the Use of the House**

One thing that has stayed fairly consistent through the three centuries that the John Brown House has seen is the use of each room within the house. As stated in Alyssa's presentation, we believe that the house was used by John Brown, its builder, on the first floor mostly for entertaining, the second for informal guests and the adult bedrooms, and the third for the children.

The Gammells, the late Victorian owners of the JBH, had a similar set-up, as can be deduced from an inventory of all the furnishings in each room of the house made in 1897, five years before Perry moved in.<sup>14</sup> The arrangement of the main house is very simple: four rooms in a square formation, east split from west by a main hallway in the center on each floor. The ell, an addition to the original cubic structure, made by John Brown's granddaughter, Sarah (Brown) Herreshoff, was enlarged by Elizabeth Amory Ives Gammell and her husband, William Gammell between 1851 and 1875, and a second and third floor added after 1887.<sup>15</sup> It is more complex and haphazard, but not included in the inventory.

The SE room on the first floor is labeled a parlor much like it seemed to be used in John Brown's time; the list of furnishings includes a music cabinet, a sofa and chairs (valued at \$100), and a mirror (much more likely used for its sociocultural value than for any "practical" use; it is the only mirror listed as being in the house).<sup>16</sup> Aside from the mirror, not many potentially decorative items are listed besides carpets in the rooms. The SW room is also labeled "Parlour," but unlike the other, is filled with at least seven places for sitting (\$111 worth of cheaper seats), and a bookcase instead of a mirror. Perhaps the SE parlor was used for dancing during parties (signaled by the mirror and music cabinet), while the SW one was used for more subdued entertainment. The NE room on the first floor (hereafter called 1NE) is labeled on the inventory as "Library." This was formerly John Brown's formal dining room. The room is notable as this so-called "library" contains only three bookcases, one "large rosewood bookcase" and two "small walnut bookcases," coming in at \$115 (Marsden Perry, as a noted bibliophile and collector, would have scoffed). 1NW probably served as a dining room in the Gammells' time. It has a cheaper carpet (to avoid costly spills), a dining table and eight "dining chairs." The "front hall" or first floor hallway contained a \$50 velvet carpet (the most expensive in the house), six chairs (worth \$100, nearly as much as the chairs in the SW parlor) and two "folding card tables." These furnishings seem to suggest that the front hall was used for entertaining or some other form of gathering, just as was the parlor.

The east wing of the second floor clearly contained bedrooms (or "chambers" as they must have been called) for the family, perhaps for Elizabeth Ives and her husband, the master bedrooms. They are filled with beds, pillows, and cheap carpeting (apparently not meant to impress, but still worth all together \$306 and \$367, respectively). The west wing of the second floor is mentioned in the inventory

---

<sup>14</sup> Robert Ives Gammell and William Gammell, *[Inventory of the JBH] (at the RIHS library)*, 1897).

<sup>15</sup> Carole Blanck, "The Family That Lived in the Mansion on the Hill (at RIHS Library)," [unpublished].

<sup>16</sup> See Deetz, James, *In Small Things Forgotten: an archaeology of early American life*. New York: Anchor, 1996.

as the “Wing of the House” differentiating it from the east wing for reasons which are unclear. It contained a “Sitting Room” (valued at \$60), a “Chamber” (valued at \$153), and a “Dressing Room” (\$88). This is pure speculation, but the wing could have been for the use of one specific member, separating it from the rest of the house. It could have potentially been for use by Robert Ives Gammell, the son who owned the recently discovered Hale Ives House. The rooms, especially the bedroom, are much less costly (and smaller and more cramped, it seems, as the two rooms, 2NW and 2SW, were separated into three) which would have made sense if he did not use the rooms often.

The third floor contains the most expensively appointed bedroom (3SE) worth \$468. It contains a “Child’s Mahogany Bureau” which means it was probably used originally to house the Gammells’ five children before they grew up. 3NW had several bookcases and a music stand (the room, totaling to \$239), perhaps used as a nursery or schoolroom. The 3SW is labeled as a “Chamber” but only contains an “Ebony Bedstead” and a mahogany marble-top table. There is actually an explicit reference to this room in an 1889 letter from an “E. Carlile” who mentions, in passing, her memories of visiting “Cousin Anna” in the JBH, probably referring to Sarah Herreshoff’s daughter, Anna Frances Herreshoff, who died almost exactly two years before the letter was written (the Herreshoffs were residents of the house before the Gammells).<sup>17</sup> She fondly recalls staying in the SW “guest chamber” on the 3<sup>rd</sup> floor. It is safe to assume that the room was used for the same purpose in the Gammells’ time, though it does not seem very welcoming when considering the sparseness that two furnishings would produce in a room that size. The “Main Hall” for the children’s floor was more richly appointed than the hall on the second floor, with chairs and tables, totaling to \$80, suggesting once again some other use. One must keep in mind that the Gammells’ children were already grown up by 1897 when the inventory was taken and the third floor hall could have been put to use as another sitting area, however it is interesting, if the floor was not still used for young children, that the bedroom still contained a child’s bureau.

The house’s furnishings, listed all together are valued at \$3,953. Increasing the value of the contents is perhaps one of Marsden Perry’s larger changes to the house. He was a collector of the most lavish pieces of Chippendale furniture and had many of the rooms decorated and renovated for outrageous sums of money. The raw property value of the house must have skyrocketed after Marsden Perry bought it. There could have been several reasons for the Gammells’ low valuation of the house: because they were already planning on moving; because they didn’t spend much time in the house; or because they were actually low on funds. If they were planning on moving, they could have already moved their more personal belongings out of the house, leaving the furnishings behind for the next family, or simply did not include the belongings they were planning on taking in their tallying of the property value. It would not be strange if they had considered selling the house, since, after Arthur

---

<sup>17</sup> William Richard Cutter, New England families, genealogical and memorial (New York: Lewis Historical Publishing Company, 1914).

Gammell's death, the rest of the family spent most of their time in Newport or Europe and Robert Ives Gammell and his wife had already started living elsewhere on the property since 1876.<sup>18</sup> Also, Elizabeth Gammell had died in April.<sup>19</sup> Another possibility is, because of the document's official looking nature (Robert and William signed on the last page), that it was a document used for purposes of taxation and they were simply trying to evade paying higher taxes. The possibility that they were not wealthy is not very convincing as the Gammells had done a fair amount of renovating themselves (even less than a decade before).

### **The Hale Ives House**

The house in which Robert and Eliza Gammell lived was the one built in the yard of the JBH sometime between 1832 and 1857. It was knocked down very soon after Perry purchased the property (in 1923) which abuts the JBH. He had bought the land for \$100, the same amount as he had bought the property with the JBH on it for.<sup>20</sup> This seems to reinforce the idea that the Gammells had ceased to care about the JBH or else were in dire financial straits, with Perry taking advantage of them. Possibly, there was something more sinister involved, such as blackmail or some sort of deception concerning the preservation of the house. After all, the only change that he announced he would make while in the process of acquiring the JBH – found among these sources – was to install modern plumbing in it.<sup>21</sup> However, this soon proved to be untrue as Perry started making many more major changes to the House and especially to the Hale Ives homestead in its yard.

There is a lot of documentary evidence concerning the chains of ownership of the property on the Charlesfield (northern) side of what is currently known as the John Brown House yard, but most of it has been covered in great detail by last year's site report. The task of this year's report is to compare the documentary evidence with the new-found archaeological evidence. As can be seen in Figure 1 below, there is a circle around the area in which the two years' digs have been excavating to expose the blue, resistant feature that runs along Benefit Street.

---

<sup>18</sup> Tuesday, October 8, 1901 Famous Mansion Bought by Marsden J. Perry, 11/13 2009  
<<http://proteus.brown.edu/archaeologyofcollegehill/admin/download.html?attachid=4490244>>.

<sup>19</sup> Elizabeth Amory Ives Gammell, [Last Will and Testament] (at RIHS library), 1897).

<sup>20</sup> Krysta Ryzewski, 2008 Class of Archaeology of College Hill, and Brad Sekedat, "John Brown House Archaeological Report," Brown University, 2008.

<sup>21</sup> Tuesday, October 8, 1901 Famous Mansion Bought by Marsden J. Perry, 11/13 2009  
<<http://proteus.brown.edu/archaeologyofcollegehill/admin/download.html?attachid=4490244>>.

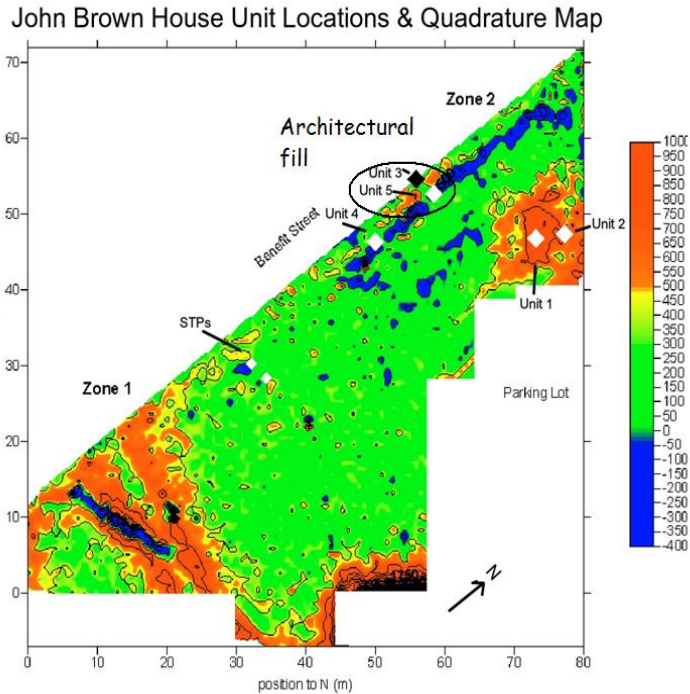

Figure 1. Location of Architectural Fill

The documents would imply that the feature is probably a fill from the demolition or a foundation remaining from when the Hale Ives House was on that same spot. However, as can be seen in Figure 2, a blow-up of a 1875 map of the location (from last year's report), though the house is in line with Benefit Street on a NW-SE line (as is the feature), there should be considerably more house/remains of the house in Zone 2, completing the outline of the house at least.



Figure 2. 1875 map of the John Brown House property showing Hale Ives House location.

This could be because the foundation was disturbed when the parking lot was put in, marked clearly in Figure 1, or the geophysical analysis could have been interrupted by the presence of so much accumulated asphalt. If the feature was simply architectural fill (which is what some of contexts seem to be), the buried remains of the demolition, then surely there would have to be more length to the original deposit or else greater depth of deposition (both of which do not seem to exist, unless the architectural fill is deeper in the sections we haven't dug yet).

Some other inconsistencies remain. Last year's dig identified four contexts (spread over two layers) excavating over what should have only had two contexts if it is to be consistent with the contexts

that were declared over the feature during this year's dig. This could easily be explained by guessing that the threshold for declaring a new soil change was higher this year. All the contexts declared in both years seem to have various important characteristics in common, however: yellowy soil color, gravel inclusions, and, as the soil approaches the feature, mortar.

The reason for Perry's destruction, however archaeologically mysterious, is more complicated. It appears to go back to his need once again to impress the older moneyed classes. A house built at least fifty years after the Colonial period – especially one in the yard of the “the most magnificent and elegant private mansion that [Adams had] ever seen on this continent” (as John Quincy Adams once said)<sup>22</sup> – must have paled in comparison, at least in its reputation, no matter how fine or how much bigger the Hale Ives House was (compare Figure 3 [JBH] with Figure 2 from the same plat map).

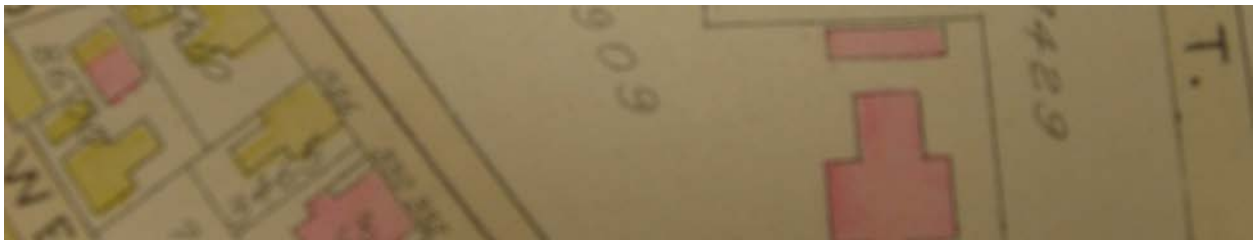

Figure 3. 1875 map of the Hale Ives House.

### **Perry's Use of the House**

Perry had made the most drastic change to the Hale Ives House one could, but did not seem to change many of the uses of the rooms in the JBH. While it is hard to say when Perry decided to change the uses of the rooms he did, it is certainly possible to assign uses to them. 1SE was still probably used as the formal parlor, but 1SW is harder to determine. Possibly it was still used for entertaining, but it is difficult to determine these kinds of things without the amount of detail that the inventory of the house from 1897 gives. Some of the only indications of room uses come from notes made by builders and contractors working on the house and the only notes extant seem to be ones from renovations after 1920. This can sometimes frustrate efforts like these. 1NE was again changed in its use, from dining room (in John Brown's time) to library to “music room,” shown with the player piano in this photograph from the period (Figure 4).

---

<sup>22</sup> quoted in [John Brown House \(Providence, Rhode Island\)](http://en.wikipedia.org/wiki/John_Brown_House_(Providence,_Rhode_Island)) - Wikipedia, the free encyclopedia, 11/7/2009 2009, 11/13/2009 2009 <[http://en.wikipedia.org/wiki/John\\_Brown\\_House\\_\(Providence,\\_Rhode\\_Island\)](http://en.wikipedia.org/wiki/John_Brown_House_(Providence,_Rhode_Island))>.



Figure 4; (Johnston) <sup>23</sup>

The higher value of the furnishings must be apparent even from a cursory glance. Note also that the plaster ceiling decorations are contemporaneous.

1NW was probably the dining room, since the kitchen was still adjacent to this room, in the ell, and a butler's pantry (built to house Perry's fine porcelains; also worth noting is that John Brown collected china as well) was put in where the west door used to be.<sup>24</sup> The front hall was probably not used for entertaining like it was in the Gammells' time. This can be seen in a picture taken at some indeterminate time, but probably before John Nicolas Brown bought the house and took down the

---

<sup>23</sup> Although the source said that the picture was taken between 1900 and 1950, this seems very unlikely. Perry did not formally gain ownership of the house until 1902 (Providence Recorder of Deeds Office, [[Chains of Ownership relating to the John Brown House \(Plat 16, Lot 530\) and the Hale Ives House \(Plat 16, Lot 150\)](#)].) and did not put plaster ceilings in the music room until 1924 (Alfred E. Stone and Carpenter, Edmund R. et al., [[Stone, Carpenter and Sheldon Papers](#)] (at RIHS library)).

<sup>24</sup> Antoinette Downing (?), [[Notes fr. A. Downing's old files](#)] (from JBH archive), 1979 (unpublished).

Spanish leather wall-hangings. There are no chairs or even end-tables in it; it is disconcertingly empty.<sup>25</sup> But to be truly critical, we must assume that the furniture was taken out of the hall for the picture, perhaps to document the wall-hangings before they were taken down.

The second floor is more mysterious in its usage. 2NW can be fairly definitively named as Perry's bedroom, whereas the whole west wing in the Gammell house was ill-defined. 2SW, which was connected by an arched passageway to 2NW, might have still been a sitting room.<sup>26</sup> There is, however, an undated "plan of alterations" for the second floor drawn up by Stone, Carpenter and Willson that labels all the main rooms as "Chambers." It also shows a small walled-off space in between 2NW and 2SW which could have been the third room in the west wing that the Gammells seem to have made. In Perry's time it consisted of two "Passages" and two closets opening off of one of them. The servants' quarters are also on this floor and differentiated from the "Chambers" by being called "Bed Rooms." They seem fairly well-appointed however, each having its own closet and a bathroom shared among them, only a little smaller than one of Perry's bathrooms on the same floor.<sup>27</sup>

3SE's use seems to have stayed consistent. It is once again labeled as a bedchamber, possibly for children, though the Perrys seemed only to have one child, Marsden Perry Jr. who is not often mentioned.<sup>28</sup> The rest of the rooms are unlabeled.

### **Perry's Move**

There are two really clear periods of renovations and changes to the house. When Perry first moved in, he installed plumbing and electricity, but accompanying these necessities were several more major, but also seemingly "unnecessary" changes. He appeared to stay true to the house's Colonial past (more than the Gammells had at least, who made some minor changes, like adding delft tiles to the mantel in the formal parlor),<sup>29</sup> while, at the same time, moving towards a forced composition of styles. It appears that he wanted both access to his Colonial past, as well as a more Classical (Western) past, trying to tap into these two reserves of cultural power to demonstrate his unconvincing sophistication and legitimize his newly earned money.

The order and importance of renovations are once again hard to determine, as the records of this set of renovations are scarce, but, if we assume that all the renovations that did not occur in the 20's occurred in the 00's, then we can generate a short list.

---

<sup>25</sup> [\[Front hall of the JBH with leather wall-hangings still up\] \(at RIHS library\)](#), [Unknown].

<sup>26</sup> Antoinette Downing (?), [\[Notes fr. A. Downing's old files\] \(from JBH archive\)](#), 1979 (unpublished).

<sup>27</sup> Carpenter Stone and Willson, [\[Plans of alterations to mansion on Power Street, Providence, RI for Marsden Perry, Esq.\]](#), [undated].

<sup>28</sup> *ibid.*

<sup>29</sup> Antoinette Downing (?), [\[Notes fr. A. Downing's old files\] \(from JBH archive\)](#), 1979 (unpublished).



It must have been around this time (the 00's) that the marble started to be put in. The driveway was coated with marble and a marble electrical panel was put into the new basement.<sup>30</sup> The entire exterior was covered with marble, obscuring the original façade of brick imported from England, because of its rarity in the colonies.<sup>31,32</sup> A marble mantel facing (actually consistent with an original marble fireplace elsewhere) is still in the formal parlor (1SE).

Perry also had the rest of a half-finished cellar dug out, even though at one point he needed to reinforce the brownstone in the portico from below with steel beams, taken out by the RIHS in 1990. He put a wine cellar and a Shakespeare library in his new basement, complete with three windows to the outside, fire-proof vaults and a reading room with elaborate brickwork archways with tile ceilings.<sup>33</sup> The question must be asked however, "What were the chances that someone would even actually see his reading room tucked away in the basement, supposedly used for his own intellectual edification and the reading of his private Shakespeare collection?" This seems to be an example of the slightly egotistical nature of Perry's renovations, his need to prove himself through his large expenditures.

He had the west door that seemed so unusual and so characteristic of the JBH in particular, bricked over, and added the entrance hallway to 1NW. He moved the laundry room to the carriage house he had built kitty corner to the property.<sup>34</sup> He added multiple modern bathrooms with lavish tile decorations and at least one fashionable ribcage shower of the kind that Mott Iron Works used to make.<sup>35</sup> Interestingly enough, Perry (or his executors) seems to have picked a similar design to one that was found in a Mott catalogue for the tiles and tub in one of the bathrooms (the pattern was on a \$200 porcelain bathtub) (Figure 5 shows a picture of the tiles).<sup>36</sup>



Figure 5. Architectural tiles

---

<sup>30</sup> *ibid.*

<sup>31</sup> Santos

<sup>32</sup> Tuesday, October 8, 1901 Famous Mansion Bought by Marsden J. Perry , 11/13 2009  
<<http://proteus.brown.edu/archaeologyofcollegehill/admin/download.html?attachid=4490244>>.

<sup>33</sup> Antoinette Downing (?), [Notes fr. A. Downing's old files] (from JBH archive), 1979 (unpublished).

<sup>34</sup> *ibid.*

<sup>35</sup> Vintage Plumbing Bathroom Antiques - The J.L. Mott Iron Works, 2009, 11/29 2009  
<<http://www.vintageplumbing.com/theilmottironworks.html>>.

<sup>36</sup> Mott Iron Works' Catalogue 'R' (from JBH archive), 1897).

## Perry's Late Renovations

The original campaign of renovations in the 1920's seemed to be geared towards repairing many of the things he had installed in the 1900's, but it soon snowballed into another round of questionable additions.

A marble pergola (or colonnade) was put into the yard near the ell in 1923 and a marble balustrade next to that with marble running along the brick path. He replaced the brick in the laundry area of his carriage house with brownstone ashlar blocks. He added steps and railings to the western doorway which had been bricked over, perhaps after having realized its interest. The refrigerator he had installed in 1902 was taken to at least three contractors in 1925 before one agreed to add another food compartment to it.<sup>37,38</sup> This seems to demonstrate a certain element of stubbornness in the character of his renovations as well.

Around this time, Perry had the infamous Spanish hand-tooled leather wall panels with gilt detailing installed in the main hallways on every floor. The panels are very reminiscent of the wall paintings found at Pompeii, with Classical scenes, framed by pillar motifs, bunches of grapes and other natural signs in the Roman style. Though many of his renovations were fairly consistent with the Colonial or Revival styles, these panels seem much more Neo-Classical in their nature. He also had much of the original, slightly loud wallpaper taken down and whitewashed the walls (although he is quoted as saying that he bought 2 George Street for its old, Colonial wallpaper).<sup>39,40</sup> This seems very Neo-Classical as well, and part of a campaign of marbling, whitewashing and ivory detailing, all common misconceptions about the "whiteness" of Roman design. As can be seen at sites like Pompeii, Rome was actually a very colorful place.

He made some changes to the landscape around the house as well. He was the first to put in the herring-bone bricks and flagstones around the house, and probably the wall and fence that still surround the house as well (though interestingly enough there is no record of precisely *what* these things were walling off; after all, there is evidence of an iron fence on the geophysical survey near the Hale Ives House, though why precisely Perry, rather than the Gammells, say, would have built a fence there is unclear).<sup>41</sup>

---

<sup>37</sup> Antoinette Downing (?), [Notes fr. A. Downing's old files] (from JBH archive), 1979 (unpublished).

<sup>38</sup> Stone and Carpenter, Edmund R. et al.

<sup>39</sup> Antoinette Downing (?), [Notes fr. A. Downing's old files] (from JBH archive), 1979 (unpublished).

<sup>40</sup> "[The Bigges]t Private Shakespeare Collection in the World (from JBH archive)," The Providence Journal 1902.

<sup>41</sup> Antoinette Downing (?), [Notes fr. A. Downing's old files] (from JBH archive), 1979 (unpublished)).

## Concluding Remarks

Perry was certainly an interesting person, if nothing else. To understand the character of these renovations, we must keep in mind his aspirations of upward mobility, his desperate desire for a cultural heritage and his waning political and economic power. After the financial panic of 1907, "Marsden Perry's active and productive years ended... he was never to regain the power he once commanded."<sup>42</sup> The years when he and his business partners had owned a senator in the Steering Committee were long gone.<sup>43</sup> These factors could have lent more stake to his other motives and strengthened his drive to achieve the ideal he held of cultural sophistication. In the end, his marks still remain on the house, despite the RIHS' best efforts, and that's the way, I think, he would have liked it.

## Works Cited

[Front Hall of the JBH with Leather Wall-Hangings Still Up] (at RIHS Library), [Unknown].

[Letter from E. Carlile to Francis Family] (at the RIHS Library), 1889.

"[The Bigges]t Private Shakespeare Collection in the World (from JBH Archive)." The Providence Journal, 1902.

[Unknown]. [Deed of Ownership from Harriet Shaw Safe to Marsden Perry] (from JBH Archive).

[various Stages of Occupation at the Property at 52 Power Street] (from JBH Archive).

Aldrich, Lucy T. [Special Committee Report Considering the Possibility of Acquiring the JBH to use as Headquarters for the RIHS] (at the RIHS Library), 1941.

Antoinette Downing (?). [Notes Fr. A. Downing's Old Files] (from JBH Archive), 1979 (unpublished).

Blanchard, Eugene V., et al. Brown University Honors Theses, 1964, 1964.

Blanck, Carole. "The Family that Lived in the Mansion on the Hill (at RIHS Library)." [unpublished].

Broadhurst, Raymond. Marsden J. Perry and Others (Manuscript at RIHS Library).

---

<sup>42</sup> Blanchard, et al, p. 69.

<sup>43</sup> Lincoln Steffens, "Rhode Island: A State for Sale," McClure's Magazine 1905.

Cutter, William Richard. New England Families, Genealogical and Memorial. Vol. 1. New York: Lewis Historical Publishing Company, 1914.

Deetz, James. In Small Things Forgotten: An Archaeology of Early American Life. New York: Anchor, 1996.

Downing, Antoinette F. et al. [JBH Binders] (at RIHS Library).

Gammell, Elizabeth Amory Ives. [Last Will and Testament] (at RIHS Library), 1897.

Gammell, Robert Ives, and William Gammell. [Inventory of the JBH] (at the RIHS Library), 1897.

"History, Reminiscences, Description of Marsden Perry's New House (from JBH Archive)." The Providence Journal, 1901.

Ives, Robert Hale. [Robert Hale Ives' Last Will and Testament] (from Brown University Library), 1875.

"J.L. Mott Iron Works - Wikipedia, the free encyclopedia." 7/17/2009, 2009.

<[http://en.wikipedia.org/wiki/J. L. Mott Iron Works](http://en.wikipedia.org/wiki/J._L._Mott_Iron_Works)>.

"John Brown House (Providence, Rhode Island) - Wikipedia, the free encyclopedia." 11/7/2009, 2009.

<[http://en.wikipedia.org/wiki/John Brown House \(Providence, Rhode Island\)](http://en.wikipedia.org/wiki/John_Brown_House_(Providence,_Rhode_Island))>.

Johnston, Francis Benjamin. [Marsden J. Perry Home, Providence, RI. Interior Scene, Detail of Piano, Crystal Chandelier, Mirror, and Door], [between 1924-1950].

Lockwood, Luke Vincent. "Colonial Furniture in America." 8/19/2009, 2009.

<<http://chestofbooks.com/home-improvement/furniture/Colonial-Furniture-America/The-Period-Of-The-Cabinet-Makers-1750-1840-Part-7.html>>.

"Marsden Jaseal [sic] Perry." 2004. <<http://www.redwoodlibrary.org/notables/perry.htm>>.

McManaway, James G. "Marsden Jaseal Perry." Grolier 75. Ed. Alexander Davidson et al. New York: The Grolier Club, 1959, 61.

Mott Iron Works' Catalogue 'R' (from JBH Archive), 1897.

Perry, Amos. The Town Records of Rhode Island: A Report, Volume 7. Ed. J. Franklin Jameson and Amasa M. Eaton.

Providence Journal. "Tuesday, October 8, 1901 Famous Mansion Bought by Marsden J. Perry."  
<<http://proteus.brown.edu/archaeologyofcollegehill/admin/download.html?attachid=4490244>>.

Providence Recorder of Deeds Office. [Chains of Ownership Relating to the John Brown House (Plat 16, Lot 530) and the Hale Ives House (Plat 16, Lot 150)].

Ryzewski, Krysta, 2008 Class of Archaeology of College Hill and Brad Sekedat. "John Brown House Archaeological Report." Brown University, 2008. 12/03/2009.

Santos, Dan. . Ed. Alex Mittman.

Stone, Alfred E., and Carpenter, Edmund R. et al. [Stone, Carpenter and Sheldon Papers] (at RIHS Library).

Stone, Carpenter, and Willson. [Plans of Alterations to Mansion on Power Street, Providence, RI for Marsden Perry, Esq.], [undated].

"Vintage Plumbing Bathroom Antiques - The J.L. Mott Iron Works." 2009.  
<<http://www.vintageplumbing.com/thejlmottironworks.html>>.

Weidner, Ruth Irwin. [Letter Concerning the Relationship between Marsden Perry's Bathroom Tiles and Mott Iron Works]. Ed. Lawrence Bacon, 199

## **CHAPTER 4 Site-wide Stratigraphy Report**

Sarah Baker

The 2009 Field Season at John Brown House began working at four distinct units. As shown on the map below, Units 6 and 7 were, respectively, in the NW corner and far West part of the property of the John Brown House (JBH). Units 8 and 9 were close to the NW corner of the house itself. Units 6 and 7 were placed in close relationship to units or shovel test pits from last year's field season. 8 and 9 were undertaken as rescue archaeology, as the NW corner of the house was a possible future location for a geothermal well. Excavation at Unit 9 halted when field workers came down on a live electrical wire, and they moved their work to a nearby shovel test pit (STP). STP3, as it was numbered, was located West of units 8 and 9, between the house's Western patio and the gravel path in the yard. The STP was located here, because this site has emerged as a more likely spot for geothermal drilling than the previous choice by the house itself.

The 2009 JBH fieldworkers assigned contexts to different stratigraphic layers as they worked. There were three possible reasons for declaring a new context. First, a new context was assigned when there was a clear change in soil color and/or texture. Second, if 10cm of depth was reached in a context without any soil change, an arbitrary context change was assigned. Finally, features and their associated soils were assigned their own contexts.

This report addresses conclusions about sitewide stratigraphy taken from this year's fieldwork, which spanned September, October and November of 2009. The report has three parts. Part 1 explores the stratigraphy of each of the 2009 units, as well as STP3. For each unit, this part of the report includes a Harris Matrix, an accompanying table of strata, contexts and soil changes, pictures, and a brief discussion of the stratigraphy. Part 2 places the 2009 units in context with one another, and outlines similarities between strata from different units. Part 3 compares this year's stratigraphy to conclusions from the 2008 field season, and attempts to draw connections across the whole site and both field seasons.

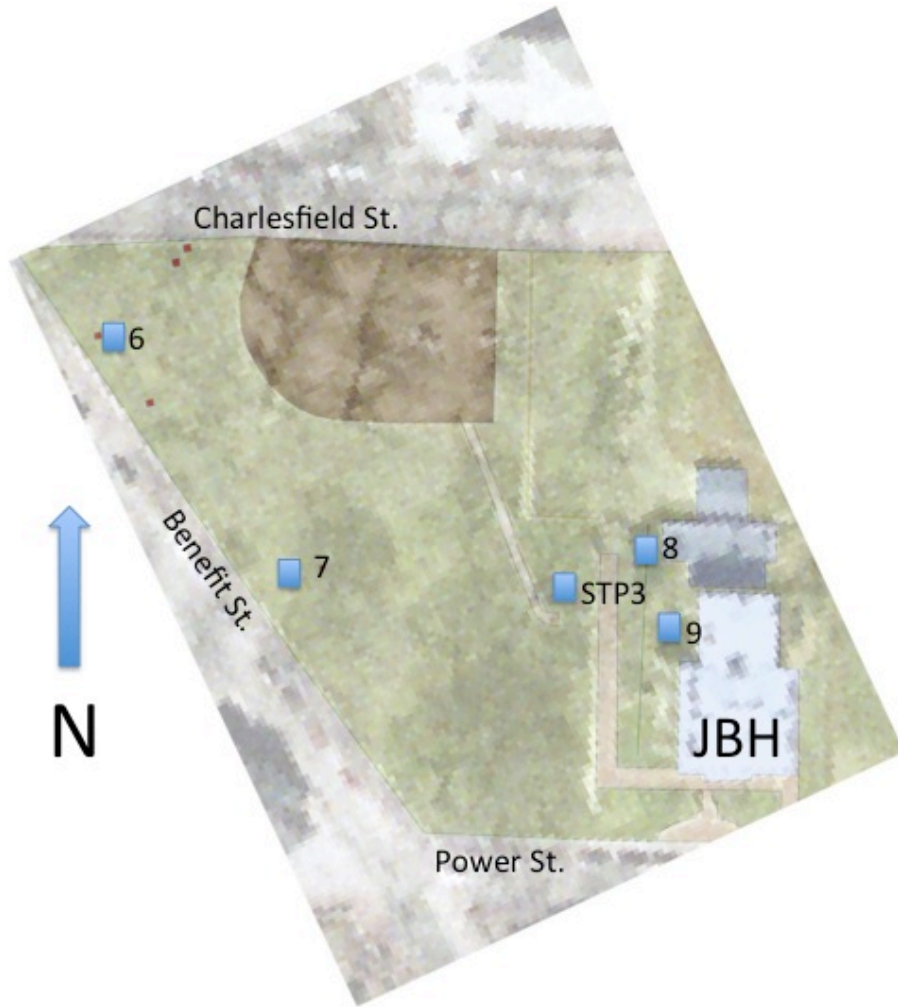

Fig. 1: Geospatially referenced aerial view provided by Krysta Ryzewski; unit locations not geospatially referenced.

## Part 1: Site Stratigraphy By Unit

### Unit 6



**Fig. 2: Unit 6 closing**

Stratum	Contexts	Soil (Munsell and/or notes)	Features
1	JBH46	10YR 3/2	
2	JBH48,54	10YR 4/3, gravelly fill	
3	JBH52	yellow/orange mottled soil	
4	JBH61	gravelly fill, broad stones	3 - stones in 61

**Table 1: Unit 6 Strata**

Unit 6 included Unit 5 from last year's field season; the 1m x 1m Unit 5 was expanded as the 2m x 2m Unit 6. After the sod and first context, JBH46, were removed, two new contexts JBH48 and JBH52 began to reveal themselves. JBH 48 was a layer of gravel-filled soil, with a Munsell value of 10YR 4/3. It cut a wide North-South swath through the unit that corresponds to the line of stones shown in figure 2. JBH52, a yellow-orange mottled soil that was full of roots; it appeared on both the East and West sides of JBH48 and persisted until the closing of the unit.



Excavators at unit 6 perceived a slight soil distinction between JBH48 and JBH54, the underlying context; JBH54 had less rubble and gravel in the soil, and was slightly sandier. However, due to the very similar soil and their close correspondence of overlay within the unit, JBH48 and JBH54 have been combined into stratum 2, as shown in table 1. Excavation ended when JBH61/Feature 3 - a grouping of large, flat stones, and the accompanying fill - was reached. The Harris Matrix below shows the stratigraphic relationships of the contexts from Unit 6.<sup>44</sup>

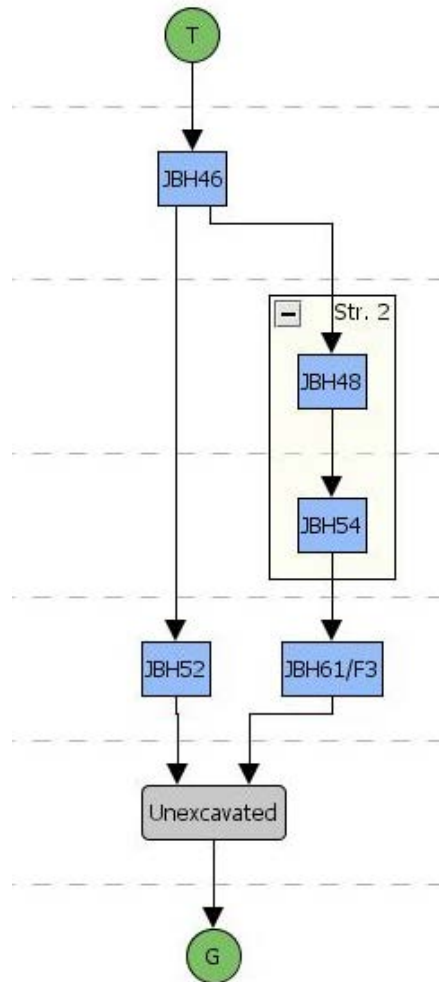

**Fig. 3: Harris Matrix for Unit 6**

<sup>44</sup> "T" in the Harris matrix corresponds to the sod/vegetation layer first removed at the opening of the unit. This demarcation will be consistent throughout this report.



Fig. 4: Unit 7 closing

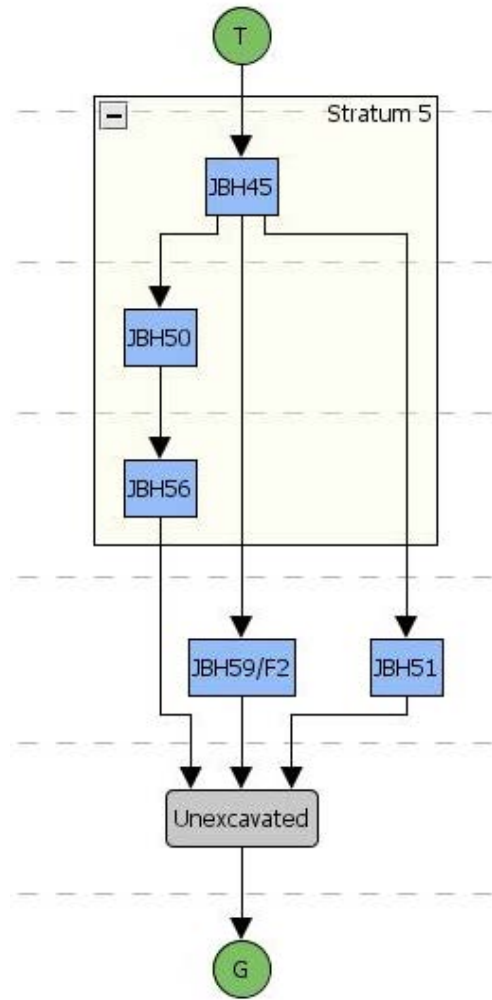

Fig. 5: Harris Matrix for Unit 7

Stratum	Contexts	Soil (Munsell and/or notes)	Features
5	JBH45,50,56	10YR 2/2	
6	JBH51	10YR 2/2 (+ rubble)	
7	JBH59	rubbly fill, broad stones	2 - broad stones

Table 2: Unit 7 Strata

As shown in the table above, the stratigraphy of Unit 7 was straightforward. After the sod was removed, the first context (JBH45) was assigned a Munsell value of 10YR 2/2, and was a very dark brown, thick clayey soil. This value persisted throughout the unit, with the only exception being the addition of gravel and rubble in JBH 51. Feature 2, a manmade architectural feature consisting of stacked

stones, mortar and rubble fill ran North-South through the feature; it began to appear at a depth of about 5-10 cm in JBH45. At this point, the excavation team divided the unit in separate contexts to the West and East of the feature; the feature serving as the dividing line between the two contexts is clearly visible in figure 4, above.

Excavation continued separately on either side of Feature 2/JBH59; the feature itself and the context containing it were not excavated during this field season. JBH51, to the West of the feature, had similar soil to JBH45, but was full of gravel, rubble and architectural fill that seemed to be associated with Feature 2. To the East, excavators reached an average depth of about 35cm with no perceived soil change from the first layer excavated. For this reason, JBH45, JBH50 and JBH56 have been combined into a single stratum. The artifacts seemed to become generally older as more depth was gained on the East side of the wall, but the team was unable to ascertain any clear divisions in the soil or in the age of artifacts found. A further complication to determining the age of these units was a modern sprinkler line that was discovered in JBH56; it can be seen towards the top of the unit in Fig. 4. More information concerning the complicated process of dating these contexts can be found in Colburn's Unit 7 Summary.

*Unit 8*



**Fig. 6: JBH58/Feature 1**

Stratum    Contexts                      Soil (Munsell and/or notes)                      Features

8	JBH43	brown	
9	JBH49,57	mottled grey-brown w/ green/orange patches	
10	JBH58	2.5Y 3/1	1 - dark "L"-shape
11	JBH62	tarp and underlying gravel	
12	JBH63	10YR 2/2	

**Table 3: Unit 8 Strata**

Unit 8 yielded the most contexts of any of the 2009 units. The layer underneath the thick vegetation at the surface was JBH43; this brown topsoil layer only persisted for a few centimeters, before the soil became increasingly mottled with orange and green patches. At this point, a new context number was assigned: JBH49. This context was followed by an arbitrary context of the same mottled soil, JBH57. At a depth of about 22 cm, the SE corner of the unit began to show a soil change. This soil lay in an “L” shape in the corner, and was much darker than the overlying mottled layer, so a new context – JBH58 – was designated and the “L” shape was designated Feature 1. This context is shown in figure 6.

As shown in Figure 7, the excavation team eventually uncovered a black tarp that covered most of Unit 8. It was peeled back, revealing a layer of dense gravel. The tarp and gravel was designated JBH62. Excavators dug to a depth of 72cm in a portion of JBH62, but were unable to ascertain a definite end of the context. This tarp predates many of the historical artifacts found in the overlying soil. This suggests that the contexts overlying JBH62 were backfill placed there sometime after the placement of the tarp; this constitutes a major disruption of the area’s stratigraphy. Finally, on the last day of excavation, there was another soil change underneath JBH58, and a new context, JBH63, was opened; this new layer was even darker than JBH58. Figure 8, below, summarizes these stratigraphic relationships.



**Fig. 7: JBH62**  
*Unit 9*

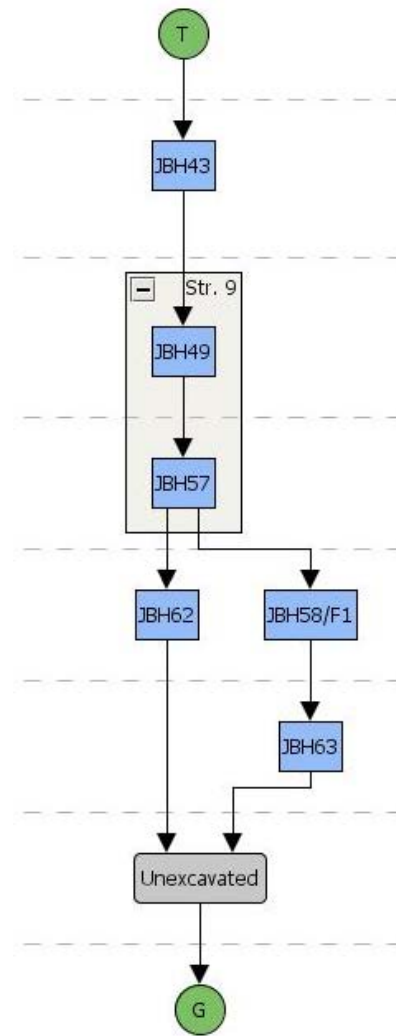

**Fig. 8: Harris Matrix for Unit 8**





**Fig. 9: Unit 9 Closing; Electrical Wire Visible in NW Quadrant of Unit**

Stratum	Contexts	Soil (Munsell and/or notes)	Features
13	JBH44	7.5YR 2.5/1	
14	JBH47+JBH53	5YR 3/2, 10YR3/2	

**Table 4: Unit 9 Strata**

Excavation at Unit 9 was cut short in the 2009 field season, because field workers came down a live electrical wire, visible in Figure 9 above. The stratigraphy that was excavated in Unit 9 before the wire was found was very straightforward. The first layer of soil (JBH44) and the two underlying layers (JBH47 and JBH 53) each covered the entire unit. JBH44 was a very dark brown/black, and was assigned a Munsell value of 7.5YR 2.5/1. Below that, JBH47 was a “mottled soil with heavy patches of light gray/brown clay” and was assigned a Munsell value of 10YR 3/2.<sup>45</sup> JBH53 was an arbitrarily assigned context, and was assigned a nearly identical Munsell value of 5YR 3/2. As such, JBH47 and JBH53 have been combined as stratum 14 in Table 4. When the team reached the wire in JBH53, a nearly uniform depth of 22cm had been achieved across the entire unit. Figure 10, below, summarizes the brief excavations that took place at Unit 9.

<sup>45</sup> Julie Pridham’s 2009 field blog, <http://proteus.brown.edu/archaeologyofcollegehill/9073>

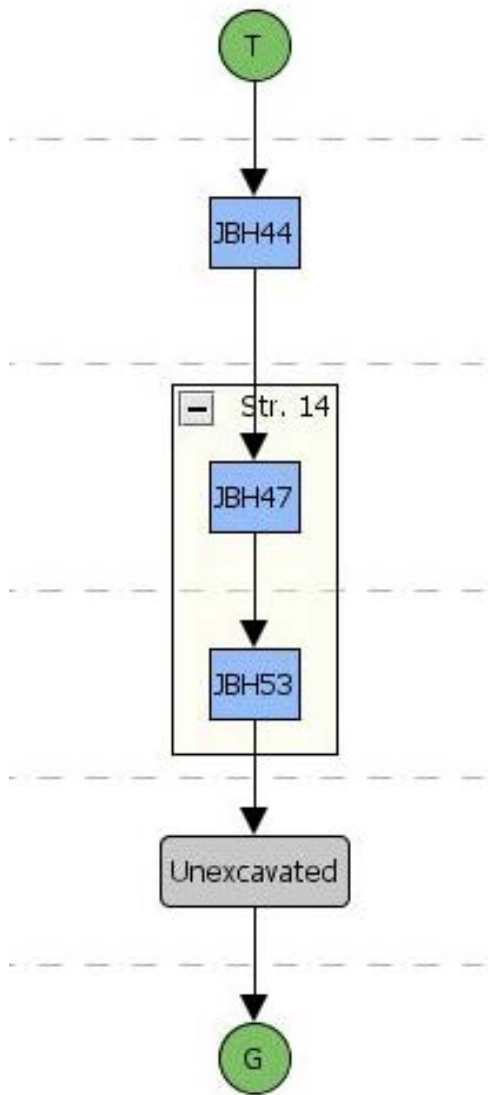

**Fig. 10: Harris Matrix for Unit 9**

Shovel Test Pit 3



Fig. 11: STP3 Closing

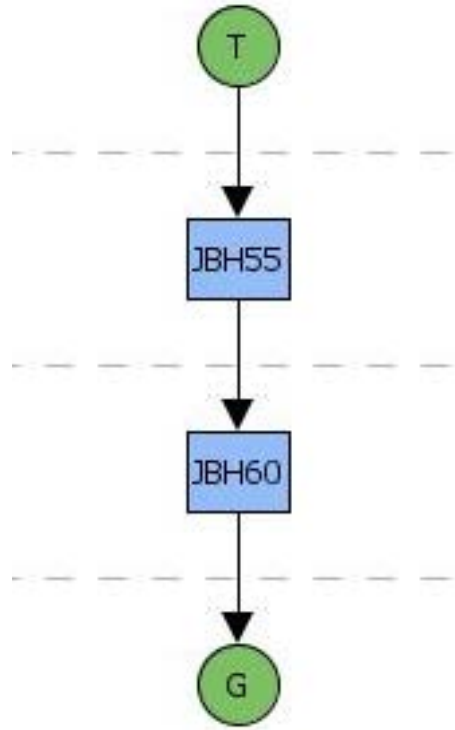

Fig. 12: Harris Matrix for STP3

Stratum	Contexts	Soil (Munsell and/or notes)	Features
15	JBH55	10YR 3/2	
16	JBH60	10YR 4/3	
17	unnumbered	10YR 6/6 (glacial soil)	

Table 5: STP3 Strata

Shovel Test Pit 3 was opened after excavation at Unit 9 closed due to the discovery of a live electrical wire. The STP achieved a lowest depth of about 40cm, and shows a classic New England stratigraphy. The STP had three layers: JBH55, JBH60, and the original glacial soil layer reached at the end of excavation. These layers rested neatly on top of each other, with a slight slant that was basically parallel to the slant of the yard at this location. The top layer, JBH55, was assigned a Munsell value of 10YR 3/2, while JBH60 was slightly lighter, with a Munsell value of 10YR 4/3. At approximately 20 cm depth, JBH60 gave way to the groundsoil, which was assigned a Munsell value of 10YR 6/6. No artifacts



were found in this deepest layer of soil, so excavators posited that they had reached the bottom of the historical soil. This is reflected in Figure 12, above, with JBH60 giving way to the groundsoil.

## **Part 2: Sitewide Stratigraphy**

Completing a sitewide comparison of stratigraphy for the 2009 field season is a difficult task for several reasons. First, the 2009 field season had several goals, such as uncovering resistive features, expanding on 2008 results, and performing rescue archaeology. As such, the units were located in vastly different parts of the John Brown House property and investigated very different soil and feature types. In contrast, the 2008 units were all located relatively near to each in the Northwestern corner of the Yard. Second, the units achieved extremely differential depths, both between the units and within each individual unit. For example, excavations at Unit 9 were prematurely halted at only 22cm, which is shallower than most of the other units. Also, in Unit 7, one half of the context was much more deeply excavated than the other, and the separation of contexts slowed work down such that deepest part was only 24cm.

Nonetheless, understanding the JBH site as a whole is an important part of analyzing the 2009 fieldwork results. Because of their proximity to each other, Units 6/7 and Units 8/9 should be considered as two separate pairs. For both of these pairs, this portion of the report will provide a discussion and Harris Matrix comparison. As a final note, the author has not considered these two pairs as completely unrelated to each other, and encourages the reader and future researchers at the JBH to think about possible similarities or new methods that could connect these two pairs in an effort to provide a broader analysis of the entire JBH site.

### *Units 6 and 7*

Units 6 and 7 were both located in the yard. Unit 6 was in the far Northwest quadrant, near or on the footprint of the Hale-Ives House, while Unit 7 lay almost directly west of the JBH site's datum in the yard of the John Brown House. Despite this distance, they shared some interesting features, including gravel fill and an architectural feature consisting of broad stones. The Harris matrices in Fig. 13 demonstrate these similarities.

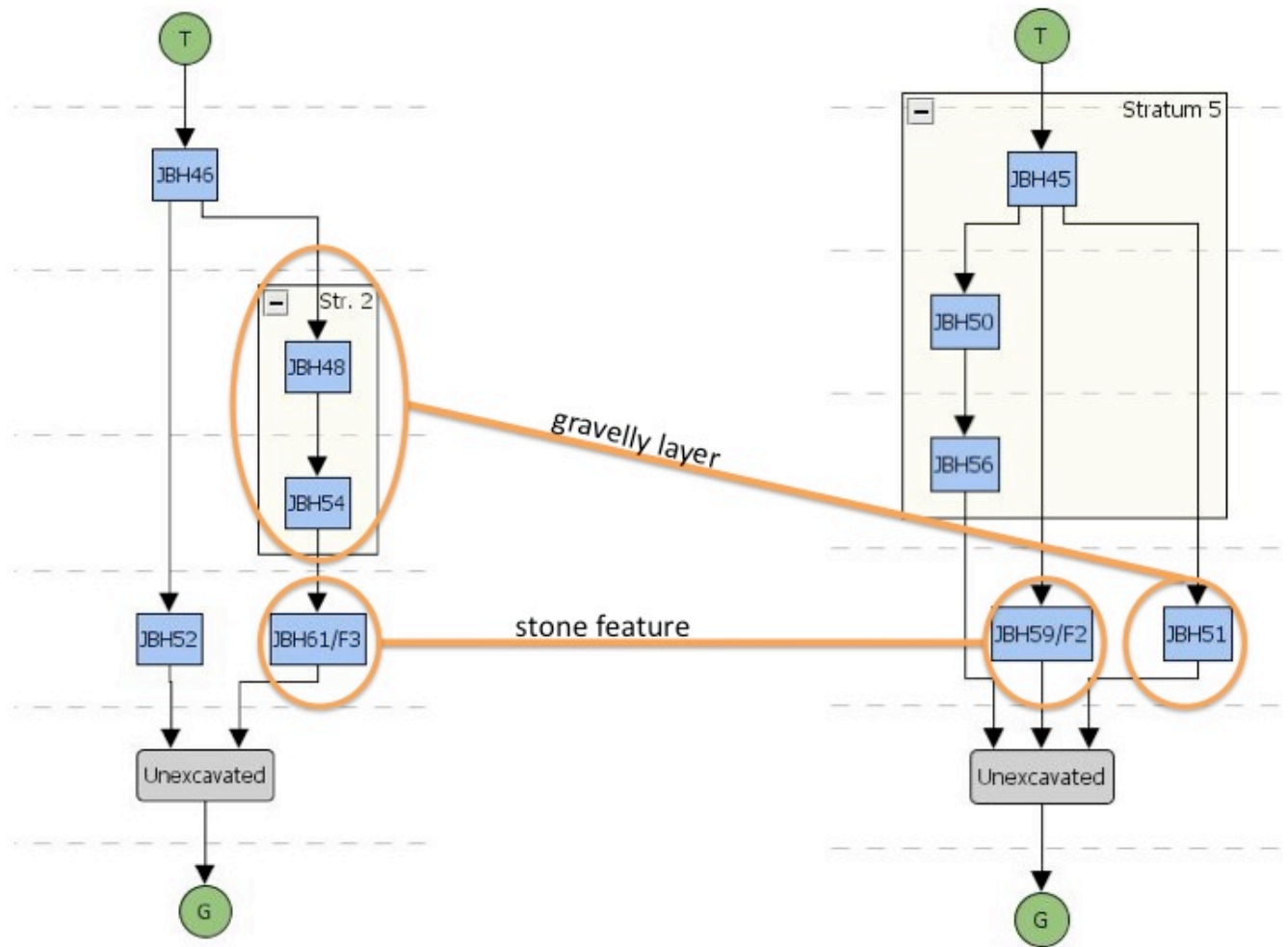

**Fig. 13: Comparison of Stratigraphy at Unit 6 (Left) and Unit 7 (right)**

While they share gravelly contexts and features, there are key differences between these similar layers in Units 6 and 7. In Unit 6, the gravelly fill was directly on top of the broad stone feature; about 28cm of gravel was excavated before reaching the broad stones in JBH61. In Unit 7, the feature began to reveal itself at a depth of only a few cm, while the fill context lay *next* to the feature. This is an important distinction in relationships between these two contexts, which on the surface may have initially seemed similar.

The other important difference lies in the stones that formed each of the two features. Feature 3 in Unit 6 consisted of many broad stones, some of which were quite large; these stones lay next to each other, covering a wide swath of the unit. The stones in Feature 2 in Unit 7, on the hand, looked quite different. These stones were much smaller on average, and were stacked up on top of one another, rather than lying flat.

This may suggest that these features had different construction methods, demolition methods or original purposes. Julie Pridham's chapter on the history of buildings in the yard of the John Brown

House delves into this question. On the basis of historical map and photo research, she posits that the feature at Unit 6 was a path. The stratigraphy discussed above could easily match this hypothesis: the layers of gravel lie above the flat paver-like stones, forming a line along what might be the foundation wall of the demolished Hale-Ives house.

It is possible that Feature 2 in Unit 7 was a path as well, with the stones forming the edge of a path that was filled with gravel and rubble. However, this would constitute a very different manner of path construction than the feature at Unit 6. This should be kept in mind when investigating the landscape architecture of the JBH property. Because of the different stratigraphic relationships and characteristics of the features themselves, coming to a decisive conclusion about these features and their functions is very difficult at this point in time. Further fieldwork might expand on Unit 7, to see whether there is a parallel feature to the West of Feature 2. Also, adding more units between Units 6 and 7 in order to establish more data points in these different construction types would be useful in determining their original purposes.

#### *Units 8 and 9*

Units 8 and 9 were located only a few meters away from each other near the house. Though Unit 9 was only excavated to a depth of 22 cm, the layers that were excavated very closely reflect contexts discovered at Unit 8. As shown below in Figure 14, after the vegetation was removed, there was a thin context of brownish soil. After a few cm of that context, both units revealed the mottled soil represented by Stratum 9 and Stratum 14.

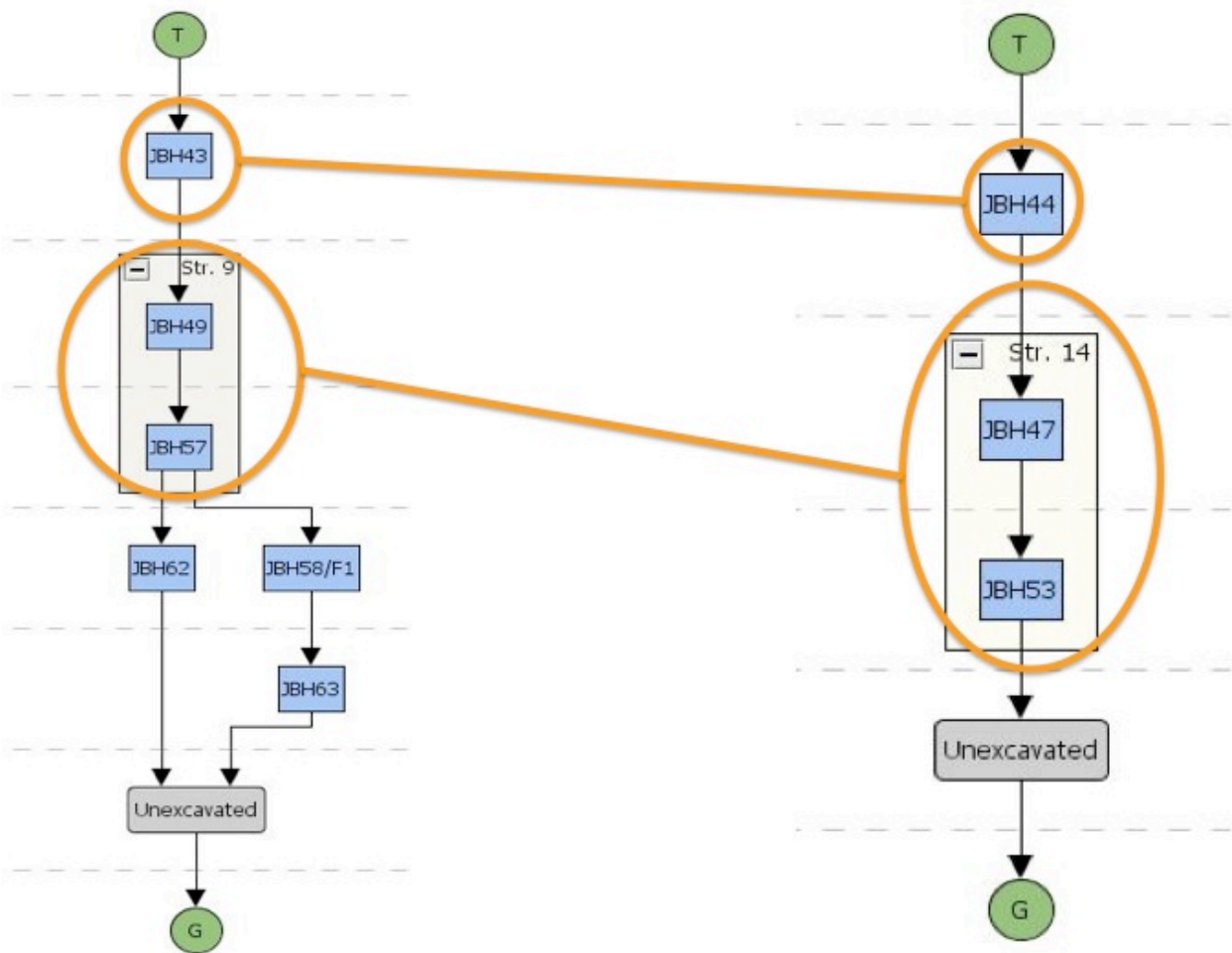

**Fig. 14: Comparison of Stratigraphy at Unit 8 (left) and Unit 9 (right)**

At Unit 8, below the contexts of mottled soil, field workers found a tarp that was likely much younger than the artifacts coming out of the overlying contexts. This would suggest that the mottled-soil stratum was backfilled over the tarp at some point; it is unknown where this backfill came from the original soil at this location, or was moved from another location. If more depth could have been gained at Unit 9, the team might have found other modern features under the mottled soil, like the Unit 8 tarp. The placement of the electrical wire, for example, likely constituted a disturbance in the stratigraphic relationships of the overlying soil. The presence of this mottled soil across both units suggests that the stratigraphy at this side “garden” of the house has been disturbed on at least one occasion in the recent past. The historical mottled-soil layers may not even have been originally located at this area of the house; this should be kept in mind while interpreting artifacts from these layers.

### **Part 3: Integration of 2008 results**

The four initial units in 2008's field season were located in the Northwest quadrant of the yard, near this year's Unit 6. After field workers discovered that one of their initial units (unit 3) was not revealing a resistive feature that they had anticipated from the results of a recent geophysical survey, they opened a fifth unit just 18 inches East of Unit 3. This unit, assigned as Unit 5, was a 1m x 1m unit, and did reveal the feature they were searching for: the broad stones of which this year's Feature 3 is a part. As mentioned above in the Unit 6 section, expanding on Unit 5 was the impetus for opening Unit 6 in the 2009 season. Because these units directly overlap, a comparison of Units 5 and 6 is crucial to understanding more about the architectural feature they share.

2008's Unit 4 was located in the Northwest part of the yard, along the same resistive feature as Units 5 and 6. However, the stratigraphy and features from Unit 4 look much more like those of Unit 7 than those of Units 5 and 6. This was initially a surprise, as Units 4 and 7 do not overlap, and are also not located particularly near each other. After a consideration of Units 5 and 6, this section of the report will compare Units 4 and 7 in an effort to understand more of the history of the entire Western line of the JBH property.

#### *Units 5 and 6*

Unit 5 is located within Unit 6, so it is unsurprising that they share very similar strata. Integrating the expansion of the original small unit will give future teams working at the JBH a better understanding of the underlying, still somewhat enigmatic feature located here. Below are Harris matrices for both units, and a table comparing notes from both seasons:

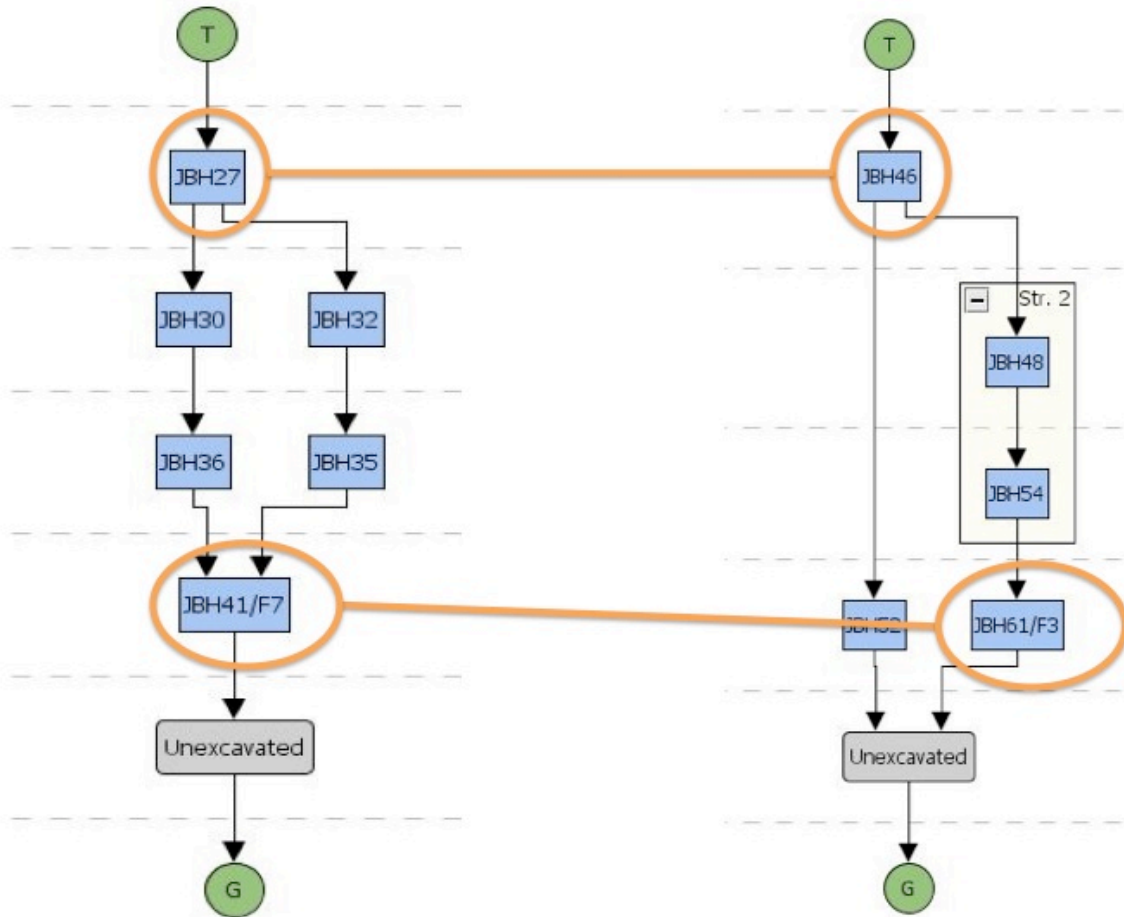

Fig. 15: Comparison of Stratigraphy at Unit 5 (left) and Unit 6 (right)

2009 Strata	2009 contexts	2009 soil notes	2009 Features
1	JBH46	10YR 3/2	
2	JBH48,54	10YR 4/3, gravelly fill	
3	JBH52	yellow/orange mottled soil	
4	JBH61	gravelly fill, broad stones	3 - stones in 61
2008 Strata	2008 contexts	2008 soil notes	2008 Features
17	27 + 36	7.5YR 2.5/1	
unnumbered	30	7.5YR 3/1, "mixed with gravel"	
18	32	7.5YR 2.5/1 "sandy yellow patches"	
19	35	"significantly more yellow than JBH 32"	
unnumbered	41	"lots of mortar", air pockets, broad stones	7 - broad stones

Table 6: Strata from Unit 5 (bottom) and Unit 6 (top); all Unit 5 soil notes are taken from the

## 2008 field paperwork

The two units share a topsoil layer (Strata 2009-1 and 2008-17,) and a stratum containing the same feature of broad stones (2009's Stratum4/Feature 3 and 2008's Context JBH41/Feature 7). The ending depth of the topsoil layer and the starting depth of the feature were similar between the years, but the distinctions made among the layers in the middle are quite different, as evidenced by the matrices above. In order to sort out these discrepancies, a comparison should focus on 2009's Stratum 2 (JBH48 + JBH54) and 2008's stratum 18 (JBH32), stratum 19 (JBH35) and the unnumbered context JBH30.<sup>46</sup>

Similarities certainly exist in the interpretation of these layers between the topsoil and the feature: they all share a common theme of varying amounts of rubble and gravel fill, as well as sandy yellow patches of soil. Despite this theme, however, the two teams interpreted different subtle variations in the stratigraphy. In 2008, the stratigraphy was divided into three separate contexts (JBH30, JBH32 and JBH35), which varied in amount of gravelly pockets and yellowy patches; the soil seemed to become more yellow as more depth was gained. In contrast, analysis in 2009 has considered the entire depth between the topsoil and the feature to be one stratum (2009 Stratum 2).

The different interpretations between the two field seasons may reveal that the Northern half of Unit 6 (where Unit 5 is located) does actually contain more separate contexts, while the Southern half was less complicated. The differences may also be due to two separate teams analyzing their unit at different times and under different conditions; 2009 was a very wet field season for example, and this may have affected the team's description of the soil. The 2008 team working at Unit 5 also acknowledged that their unit contained "convoluted contexts".<sup>47</sup> Perhaps related to this confusion, the 2008 notes have inconsistencies. For example, the 2008 fieldnotes delineate JBH27 and JBH36 as very different contexts, with a context between them, while the sitewide stratigraphy report combines these two into a single stratum. Finally, human error in notetaking must be acknowledged as a possible confounding factor. The only safe conclusion in comparing Units 5 and 6 is that they certainly share a topsoil layer and a feature, while the strata between them have yet to be clearly understood.

---

<sup>46</sup> Because JBH52 lay outside the area excavated in 2008, I have chosen to ignore it here.

<sup>47</sup> Elyse Nuding's 2008 Field Blog, <http://proteus.brown.edu/archaeologyofcollegehill/6387>

## Units 4 and 7

While Unit 4 was closer to Units 5 and 6, and lay along the same resistive feature in the 2008 geophysical survey, the stratigraphy of Unit 4 much more closely reflects the stratigraphy at Unit 7. As discussed in the Unit 6/7 comparison, Unit 6's feature lay *under* several centimeters of gravelly soil, while Unit 7's feature lay *next to* the accompanying gravelly fill. Unit 4's stratigraphy more closely resembled the latter: there was a stacked-stone feature bisecting the Unit, with a non-gravelly, brown soil on one side and architectural rubble and gravelly fill on the other. The Harris matrices in Fig. 16, below, delineate these similarities.

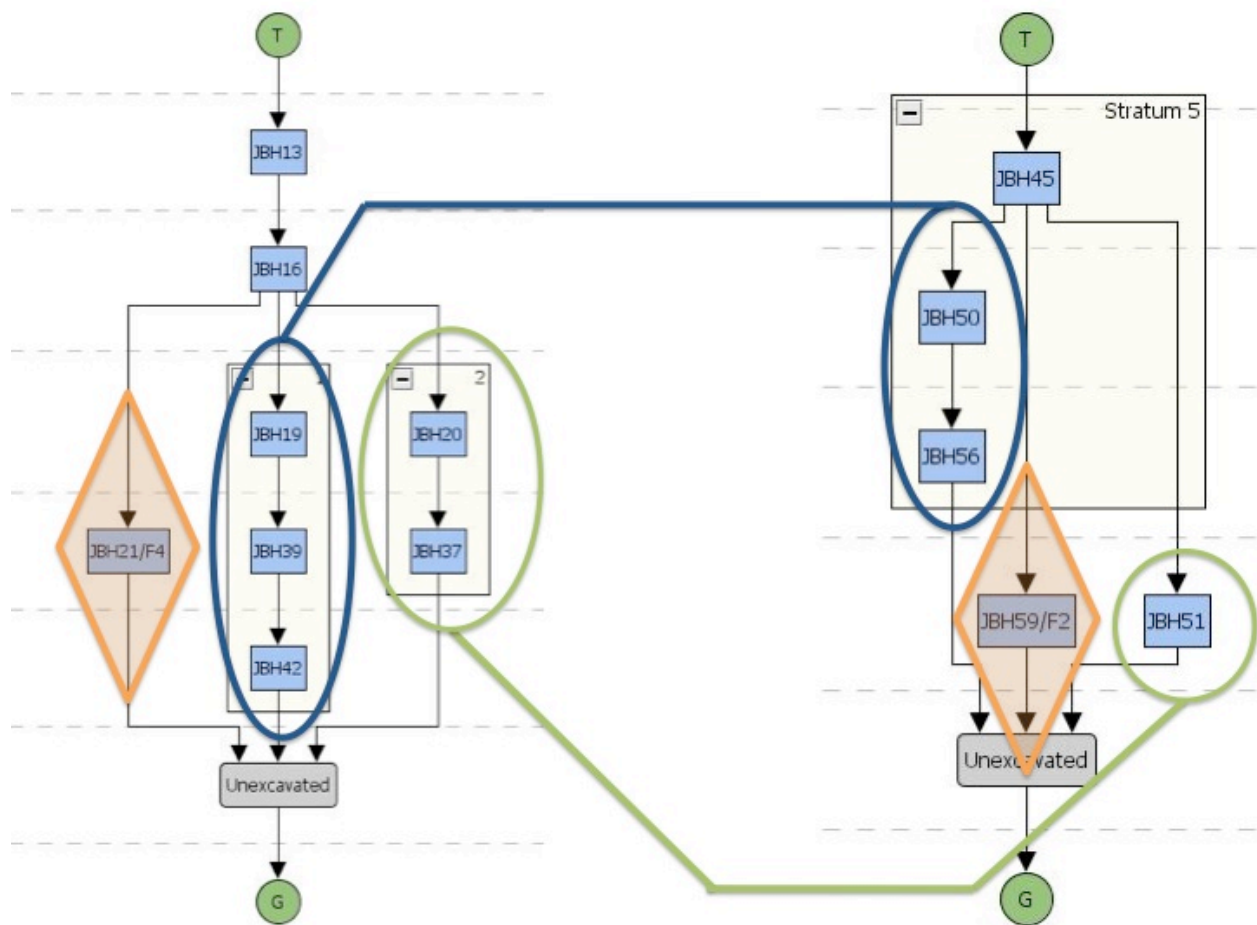

**Fig. 16: Comparison of Stratigraphy at Unit 4 (left) and Unit 7 (right)**

As shown above, Units 4 and 7 share a number of similar contexts. The two features, noted by orange diamonds in Fig. 16, were both linear rows of stacked stones, which neatly divided their



respective units into clearly distinct contexts on either side. On one side was an uninterrupted, smooth, brown soil; these strata are noted by the blue ovals in Fig. 16. Both teams assigned arbitrary contexts in this layer, as there was no perceived soil change in either for at least 10cm. On the other side was the rubbly strata denoted by the green ovals in Fig. 16. The 2008 team also got through 10cm here, and assigned a new arbitrary context; the 2009 team did not achieve a 10cm depth across the whole rubbly context.

The interesting detail in this comparison is that, in the two units, the distinct contexts lie on opposite sides of their respective features. That is to say, in Unit 4, the smooth context lay on the West side of the feature, while the rubble was on the East. In Unit 7, the opposite relationship was observed. This is fascinating, since Units 4 and 7 lie in a line with each other along the Western edge of the JBH property. This may support the hypothesis that there was once a path edged with the stony features found in both years. Unit 4 might show a snapshot of the West edge of part of the path, with smooth soil on the outside and gravel in the inside, while Unit 7 could be part of the East edge of the path, showing a mirror-image of the same relationship. Figures 17 and 18 below clearly illustrate this proposed relationship.



**Fig. 17: Features/Strata in Unit 4, 2008  
2009**



**Fig. 18: Features/Strata in Unit 7,**

These similarities are cause for further investigation at and around these two units. Perhaps expanding Unit 7 to the West would yield results like Unit 4's, with identical smooth soil on the other side of the feature. As mentioned in the Unit 6/7 comparison, expanding this unit would also aid a comparison of the seemingly different relationships between the gravel and the features in Units 6 and

7. In any case, further investigation of the resistive features along the West edge of the property should be a strong consideration in choosing the location of future units.

## **Conclusion**

The 2009 field season at the John Brown House yielded many surprises and produced many more questions. Many of these questions deal with stratigraphy: what exactly is going on along the West edge of the JBH property? Are we seeing the same landscape or architectural features, or have some of those features been reused or changed since they were first constructed? Also, when, how and why was the stratigraphy at Units 8 and 9 disturbed?

The goals of this report have been twofold. First, it has attempted to provide a brief overview of the stratigraphic relationships at the JBH discovered during fieldwork in 2009. The following chapters will address in more detail the specifics of the excavation process and artifact analysis in each unit, as well as exploring several histories related to this property. The second goal of this chapter has been to raise and attempt answer some of these questions stated above, or at least to provide future researchers at the JBH with more information as they pursue answers.

As with all archaeological work, our efforts at the John Brown House were an imperfect science. Everyone in the class had minimal or no experience with hands-on archaeology, and we learned on our feet. In an effort to expose all of the students in the class to all parts of the excavation and analysis process, there were different excavators and notetakers every week in every unit. Though I have attempted to iron out as many of these inconsistencies as possible, they likely still played a role this analysis. I take responsibility for any other inconsistencies and mistakes, as human error inevitably plays a role at every point in the process, including synthesis.

## CHAPTER 5 Unit 6 Excavation Summary

Elise Merchant

Unit 6 is located on the far West side of the John Brown House property, just to the East of Benefit Street, towards the Northern end of the property. Unit 6 is located on top of Unit 5 from the 2008 digging season. Unit 5 was a 1m x 1m square unit, and Unit 6 is a 2m x 2m square, with Unit 5 in the Northwest corner. The location for Unit 5 was decided upon last year based on geophysical surveys done in September of 2008, and on features found in another unit being dug that same season (namely an architectural feature suspected to be a wall located in Unit 4). Unit 5 was dug 50 cm away from Unit 3. Unit 3 had not shown the architectural feature, consistent with expectations based on the geophysics.<sup>48</sup>

The location for Unit 6 is in the area known to have been previously occupied by the Robert Hale Ives House (327 Benefit St.). This house was built sometime between 1832 and 1857, based on cartographic evidence.<sup>49</sup> The house was knocked down by Marsden Perry sometime between 1923 and 1926.<sup>50</sup> It is impossible to be certain that the feature found in Unit 6 (and in Unit 5 before it) was part of the Hale Ives house, but given the significant size of the feature it seems likely that it was at least associated with the building.<sup>51</sup>

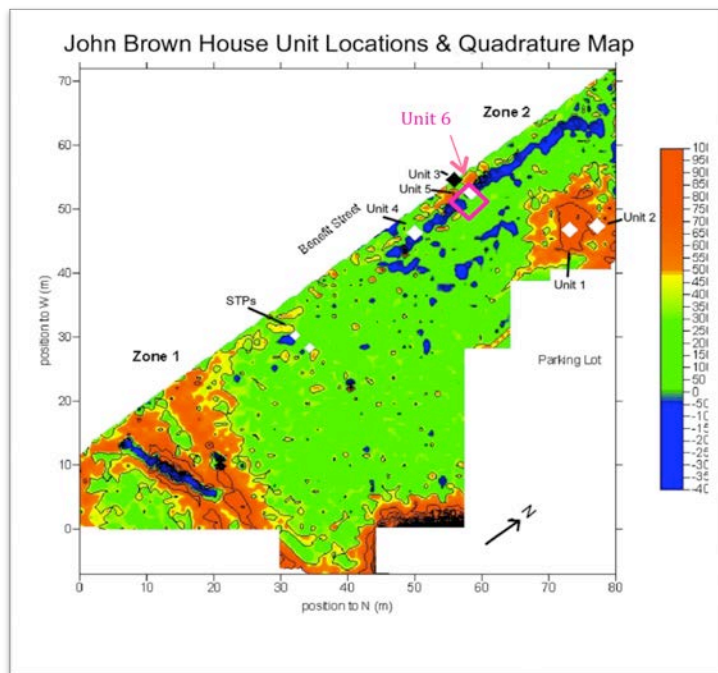

### Excavation Methods

The excavation of Unit 6 was performed by Alyssa Thelemaque, Alex Mittman, Bridget Smith and Elise Merchant, under the direction of teaching assistant Elise Nuding. To begin the excavation of Unit 6, the Southwest corner was designated the datum point, being the highest point initially. Prior to any digging, the Northwest corner was 3.5 cm bd (below datum), the Northeast corner was 12.5 cm bd, and the Southeast corner was 6.5 cm bd. Excavation initially proceeded with shovel shaving, until the first

<sup>48</sup> Unit 5 Summary by Elise Nuding, Final Report 2008, p.111

<sup>49</sup> Yellin, Steffi, Final Report 2008, p.31

<sup>50</sup> Yellin, Steffi, Final Report 2008, p.32

<sup>51</sup> Nuding, Elise, Final Report 2008, p.118

context after the topsoil was encountered, at which point the trowelling was employed. All the soil removed from the unit was sifted with ¼" mesh.<sup>52</sup>

### Stratigraphy

Unit 6 contained 5 different contexts. The topsoil layer was JBH 46. On the West half of the Unit, JBH 48 was the next context, designated by a change in soil color and consistency (large quantities of gravel and rubble "fill"). JBH 46 persisted on the East side of the Unit beyond the start of JBH 48.<sup>53</sup>

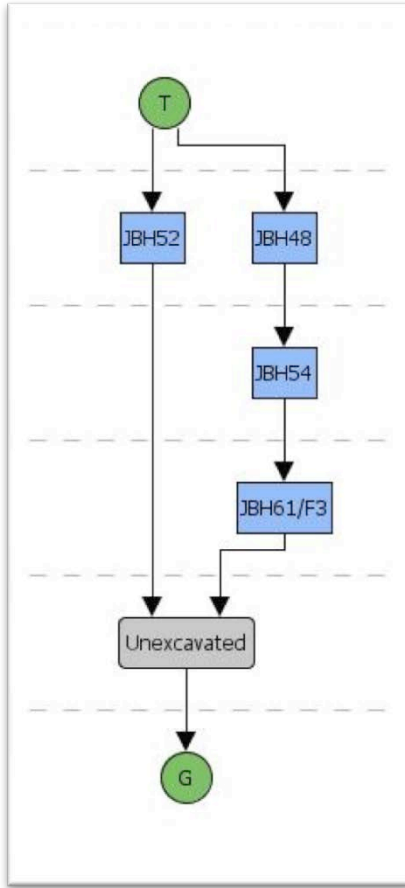

The next soil layer to be hit on the East side of the Unit was JBH 52, causing context JBH 46 to finally be closed. The context JBH 52 also included a very small triangular area in the Southwest corner of the unit. This patch was surrounded by the South and West walls and JBH 48 (and late JBH 54). JBH 52 was designated due to a change in soil color. The soil became mottled with a bright yellowish orange (the Munsell value of which was unfortunately not noted), with the background color of the soil remaining the same. JBH 52 persisted on the East side of the unit (and in the Southwest corner) until the end of the excavation.<sup>54</sup>

The next context designated was JBH 54, which occurred directly underneath JBH 48, except for a small patch of JBH 48 along the West wall of the unit in the center of the wall, where JBH 48 persisted past the level where the rest of the context had left off. The transition from JBH 48 to JBH 54 was gradual, marked by a change in rubble consistency. JBH 54 was still gravelly, but had denser sandier soil than JBH 48. This gradual change unfortunately meant that some of JBH 54 was excavated as JBH 48 before the

decision to declare a new context was made.<sup>55</sup>

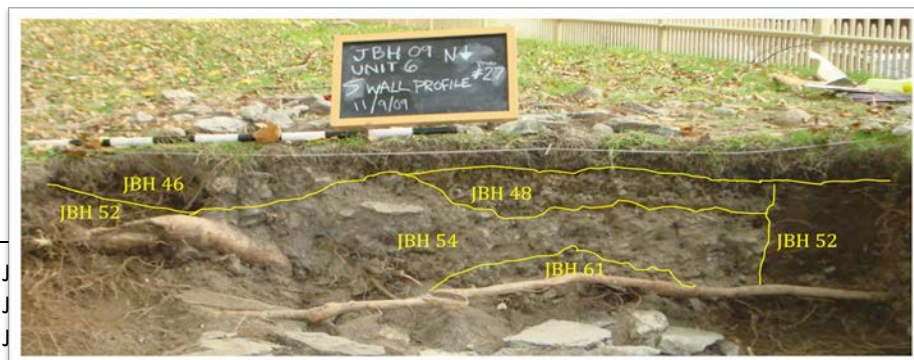

<sup>52</sup> Excavation form for JBH 46

<sup>53</sup> Excavation form for JBH 48

<sup>54</sup> Excavation form for JBH 52

<sup>55</sup> Excavation form for JBH 54

The very last context declared was JBH 61. JBH 61 is a feature level: a collection of sizeable rocks uncovered forms a wall-like feature (feature number 3) which runs through the same area that had been covered by JBH 54 and JBH 48. This feature is the same as the one unearthed in Unit 5, which was then designated feature number 7. Digging was closed with the Southwest corner at 46 cm bd, the Northwest corner 45.5 cm bd, the Northeast corner 24 cm bd, and the Southeast corner 33 cm bd.

### JBH 46

The topsoil layer was designated JBH 46. This layer was excavated primarily by shovel shaving. The topsoil layer was a dark grayish brown soil color (Munsell value 10YR 3/2) and was heavily permeated by roots which frequently required the use of root cutters.<sup>56,57</sup> This soil layer corresponds with the topsoil layer from Unit 5, JBH 27, which had a Munsell value of 7.5YR 2.5/1, and was described as “sandy silty soil of loose compaction”.<sup>58</sup>

Context JBH 46 extended fairly deep on the East side of the unit, ending where JBH 52 begins, at 19 cm bd in the center of the North wall, 20.5 cm bd in the Northeast corner and 15 cm bd in the Southeast corner. The soil consistency had started to change on the East side prior to the declaration of JBH 52, with increasing clay content and mottled yellow and black colors. However, the changes were not drastic enough to declare a new context.<sup>59</sup>

On the West side of the Unit (directly South of Unit 5), JBH 46 does not extend down as far. In the Northwest corner, JBH 48 begins at 6.25 cm bd, and in the Southwest corner JBH 48 begins at 9 cm bd. The first soil color change was noted in the Southwest area of the unit, towards the center, at

approximately 7.5 cm bd. At this point, a new soil layer with a lighter yellow color (Munsell value 10YR 4/3) and a sandy consistency was found and designated JBH 48.<sup>60</sup>



<sup>56</sup> Excavation form for JBH 46

<sup>57</sup> Elise M's Excavation Blog, <http://proteus.brown.edu/archaeologyofcollegehill/9082>

<sup>58</sup> Nuding, Elise, Final Report 2008, p. 111

<sup>59</sup> Excavation form for JBH 46

<sup>60</sup> Excavation form for JBH 46



The finds from JBH 46 included pieces of brown, green and clear glass, pieces of a glass measuring cup, a wire nail, two plastic beads, a rim piece of a clay pipe, a plastic soda bottle cap gasket, a piece of brown rubber, pieces of brick, pieces of shell, a piece of plastic coffee lid and ceramics (whiteware and creamware). The two artifacts in this context which are clearly modern are the plastic soda bottle cap gasket and the piece of plastic coffee lid (although the plastic beads are also fairly modern). The plastic coffee cup lid provides a TPQ (*terminus post quem*) date of 1997, as this is the date of the first patent for a hot cup lid that has the indentations for the holding a portion of the lid folded back to create a drinking hole.<sup>61</sup> The other finds from JBH 46 all potentially

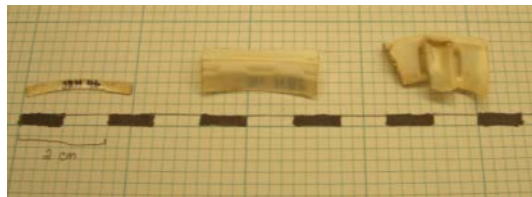

from earlier times (with

the exception of the clay pipe rim piece, which was

undoubtedly re-deposited). The finds from the corresponding context in Unit 5, JBH 27, included brick fragments, glass shards and a nail, all of which are potentially modern as well.<sup>62</sup>

Find	Date
Wire nail	1877 - present <sup>1</sup>
Brown glass	
Green glass	
Curved colorless glass	
Fragments of measuring cup	
Plastic beads	
Piece of brown rubber	
Whiteware	1830s - present <sup>2</sup>
Creamware	1762 - 1820 <sup>2</sup>
Brick fragments	
Shell	
Piece of plastic coffee cup lid	1997 - present - TPQ <sup>3</sup>
Plastic soda bottle cap gasket	1960s - present <sup>4</sup>

1 Edwards and Wells p. 61  
 2 FLMNH, *Mean Ceramic Manufacturing Dates*.  
 3 U.S. Patent number 5,613,619  
 4 Object Bio, Elise Merchant

## JBH 48

The first context to emerge below the topsoil layer was JBH 48. This context was designated based on a change in soil consistency. Where the soil from JBH 46 had been “moist, soft, dark soil”, the soil in JBH 48 was “sandy, gravelly, yellowish soil” (Munsell value 10YR 4/3). JBH 48 extended from the entire N-S length of the unit, on the West half. When JBH 48 was declared, the Northwest corner was 6.25 cm bd, the Southwest corner was 9 cm bd and at two points in the center of the new context the soil was 10 cm bd and 7 cm bd.



<sup>61</sup> U.S. Patent number 5,613,619

<sup>62</sup> Nuding, Elise, Final Report 2008, p. 111

Find	Date
Pencil fragment	1893 – present <sup>1</sup>
Whiteware	1830 – present <sup>2</sup>
Creamware	1762 – 1820 <sup>3</sup>
Red-painted creamware	
Colorless curved glass	
Ridged molded glass	1700s – present <sup>3</sup>
Shell	
Coal	
Asphalt with Cobblestone	1871 – present <sup>4</sup>
Porcelain electrical insulation	1800s <sup>5</sup>
11.5 cm spike	1798 – 1847 <sup>6</sup>
Wire nails	1877 – present <sup>6</sup>
Cut nails	1791 – 1900 <sup>6</sup>
Slate roofing pieces	
Red and yellow brick	
Mortar	

1 Elise Merchant, Object Bio

2 FLMNH, *Mean Ceramic Manufacturing dates*

3 Parks Canada Glass Glossary

4 CNEHA, "Telling Time in the Second Half of the Nineteenth Century"

5 Ansel, Evelyn, Object Biography: "Porcelain Fuse", Final Report 2008

6 Edwards and Wells

The temporally diagnostic finds for this unit include cut and wire nails, whiteware, creamware, a piece of ceramic insulation, a piece of molded glass, and a pencil fragment. This pencil fragment provides the TPQ date for this context, as it has yellow paint on the outside. The first yellow pencil in history was documented in 1854. However, it was not until 1893 that yellow pencils were being imported and manufactured in the United States.<sup>63</sup> Therefore, the TPQ date for the context is 1893. However, since the context appears to be rubble fill and given the location of the unit (based on cartographic evidence and the geophysical survey done), it seems unlikely that this context was deposited prior to the demolition of the house in the 1920s as the unit appears to be in or at least on the edge of the Hale Ives House. Given this information, and the commonality of yellow

pencils through today, the TPQ provided by this artifact should be examined critically.

There were many architectural finds among the fill which composed context JBH 48. These included many pieces of brick (quite a few of which were nearly whole) and mortar, nails (both cut nails and wire nails, including one 11.5 cm spike), other unidentifiable iron pieces, asphalt with a cobblestone imbedded within it, pieces of slate roofing, a piece of ceramic electrical insulation and a clay tube which is potentially a piece of a drainpipe.<sup>64</sup> These architectural finds may have come from the Robert Hale Ives House, possibly deposited when the house was demolished by Marsden Perry sometime before 1926.<sup>65</sup> It is equally possible that the architectural finds came from the Hale Ives House, but were re-deposited in context JBH 48 at a date later than the demolition of the house in the 1920s.

During excavation, the gravelly nature of JBH 48 and the shape of the context led the excavators to hypothesize that this context composed a pathway which ran roughly North-South across the unit. If this was indeed the case, the rubble from the demolition of the house may have been utilized to increase



<sup>63</sup> See Elise's Object Bio on pencil fragment

<sup>64</sup> Excavation form for JBH 48

<sup>65</sup> Yellin, Steffi, Final Report 2008, p. 32

the volume of the gravel fill of the path. Along these same lines, it is always possible that the architectural finds came from somewhere else entirely, deposited here at the time of the (possible) path formation, although this seems less likely.

Documentary research has supported the hypothesis that JBH 48 is the remnants of a gravel path. A photograph from 1949 (shortly after the Rhode Island Historical Society obtained the house, after the demolition of the Hale Ives House) shows a light line running from the West side of the John Brown house around the yard. This lighter line appears to be a pathway, but the photograph was taken from too high up to be certain. However, a photograph from December of 1935 showing the West side of the John Brown House clearly shows the start of a gravel pathway. It appears that unit 6 is located at least approximately on the line of the pathway, which is supported by shape of the pathway in the photograph, which matches the shape of the pathway turned up in our unit (running approximately North-South). Based on the timing of the photographs, the pathway was most likely built by Marsden Perry, who potentially built the path following the demolition of the Hale Ives House, using the rubble as



fill for the pathway. This pathway was most likely demolished sometime after May 1964, when the parking lot for the John Brown House was created.<sup>66</sup>

### **JBH 52**

JBH 52 was the next context underneath the topsoil context (JBH 46) to be uncovered on the

East side of Unit 6. In addition, a small area in the Southwest corner was also designated to be part of this same context. This context was declared based on a soil color change. The soil in JBH 52 is a mottled yellowy-orange, whose Munsell value was unfortunately not documented. The Northeast corner of the context was initially 20.5 cm bd, the Southeast corner initially 15 cm bd, and a point in the center of the unit along the border between JBH 52 and JBH 48 initially 16 cm bd. This context was fairly slow to excavate due to the high root content, including one very large root in the Northeast corner of the unit. Also of note, a distinct patch of sand (approximately 10 cm<sup>2</sup>) was found right next to the root.<sup>67</sup>

<sup>66</sup> See Pridham, Julie, Final Report 2009

<sup>67</sup> Excavation form for JBH 52



The finds from JBH 52 include pieces of unidentifiable metal, cut nails, fragments of glass (colorless, green, pink-tinted, and dark green), a fragment of porcelain bone china, china (including pearlware with a scalloped edge, a piece of a pearlware dish, and creamware) and a small molded button. The TPQ date for the unit is given by a piece of blue-printed whiteware, which has a date range of 1840-1860.<sup>68</sup>

Find	Date
Colorless curved glass	
Clear green glass	
Pink-tinted glass	
Dark green glass	
Porcelain bone china	1830 – 1900 <sup>1</sup>
Blue-printed whiteware	1840 – 1860 <sup>1</sup>
Pearlware with greenish tinged scalloped edge	1802 – 1832 <sup>1</sup>
Creamware	1762 – 1820 <sup>1</sup>
Small molded button (potentially metal)	
Unidentifiable metal	
Cut nails	1791 – 1900 <sup>2</sup>
Brick fragments	
Shell	

<sup>1</sup> FLMNH, *Mean Ceramic Manufacturing Dates*.

<sup>2</sup> Edwards and Wells

JBH 52 was the lowest context reached in the East half of the unit by the end of the excavation. This was in part because the focus of excavation was on the West half of the unit, due to the gravel and rubble fill of JBH 48 and the feature uncovered in JBH 61. The Northeast corner was particularly higher than the rest of the unit, as even within the digging on the East side of the unit more attention was paid to the center of the unit (the transition between JBH52 and JBH61), and the feature (and JBH 48 before it) ran much closer to the East edge on the South side of the unit. At closing, the Northeast corner was 24 cm bd, the Southeast corner was 33 cm bd, the middle of the unit (border of JBH 52 and JBH 61) was 34 cm bd, and the boundary between the two contexts was 33 cm bd on the North edge of the unit.<sup>69</sup>

## JBH 54

JBH 54 was declared following a consistency in the soil change from JBH 48. There was no clear distinction between the two contexts, and consequently some of JBH 54 was excavated as JBH 48. JBH 54 is still gravelly, although the soil is sandier and denser, packed around medium to small sized stones. Additionally, the architectural rubble present in JBH 48 is no longer found in JBH 54. A small patch in the center of the West wall of the unit (next to the Southwest corner of Unit 5) continued to be JBH 48, based on soil consistency.



<sup>68</sup> Florida Museum of Natural History, *Mean*

<sup>69</sup> Excavation form for JBH 52

Find	Date
Mortar	
Ridged piece of molded glass (corresponding to piece found in JBH 48)	1700s – Present <sup>1</sup>
Asphalt with cobblestone	1871 – present <sup>2</sup>
Small shard of slate	
Concrete with gravel	
Brick pieces	
Whiteware	1830 – present <sup>3</sup>
5 x 5 thin flat metal piece	
Cut nails	1791 – 1900 <sup>4</sup>
Cut spike	1798 – 1847 <sup>4</sup>
4.5 cm finishing nail	1900 – present <sup>4</sup>

1 Parks Canada Glass Glossary

2 CNEHA, "Telling Time in the Second Half of the Nineteenth Century"

3 FLMNH, *Mean Ceramic Manufacturing Dates*.

4 Edwards and Wells

The finds from this unit included many chunks of mortar, a ridged piece of molded glass corresponding to one found in JBH 48 (potentially explained by the excavation of some of JBH 54 as JBH 48), asphalt attached to a cobblestone, concrete, pieces of brick, a small shard of slate, a piece of whiteware, a marble slab, and iron pieces (one thin, slightly curved plane-like piece approximately 5 cm<sup>2</sup>, two large iron fixtures, cut nails and a cut spike, and a small finishing nail).<sup>70</sup> The TPQ date for the context comes from the small finishing nail, which dates from somewhere between 1900 and the present.<sup>71</sup>

At about 30 cm bd at the North side of the unit, the same large stones as the ones reached in Unit 5 started to appear. The soil around these stones contained much of the mortar found in JBH 54, as well as a fairly high sand content. This find prompted the declaration of the last context of Unit 6, JBH 61.

## JBH 61

JBH 61 is the only feature context in Unit 6. The wall-like feature is feature number 3. This feature is the same as feature number 7 from Unit 5 in 2008. In fact, starting with JBH 61, Unit 5 is no longer a distinction area within Unit 6, as the bottom level of Unit 5 was finally reached.

The feature runs across the unit approximately following the same path as JBH 48 and JBH 54 before it. However, JBH 61 is slightly wider than either of these two contexts had been, spanning the whole West half of the North wall and running North-South to cover the majority of the South Wall (the Eastern edge of JBH 61 exactly meets the Southeast corner of the unit, but in the Southwest corner of the unit the small patch of JBH 52 persists).

At the declaration of this context, The Northwest corner was 34 cm bd, the center of the North wall (the border between JBH 61 and JBH 52) was 22 cm bd, the center of the unit (also on the border between JBH 61 and JBH 52) was



<sup>70</sup> Excavation form for JBH 54

<sup>71</sup> Edwards and Wells, p. 59

28 cm bd, and the Southeast corner was 20 cm bd. The soil in the context contains many patches of mortar, which were not in chunks but actually mixed into the soil. Additionally, the soil contained many sandy patches.<sup>72</sup>

The finds from JBH included mortar and bricks, red tiles (1 cm thick), a shard of green glass, a shard of lead-glazed earthenware, flat iron pieces (presumably some sort of architectural support)<sup>73</sup>, cut nails, and (most interestingly), a sliding spine part of a report cover. The TPQ date for this context clearly comes from the plastic spine. The earliest patents for devices resembling the simple spine date back to 1970.<sup>74</sup> However, these patents only resemble the spine. The patent which actually appears to be for the exact type of spine found does not appear until 1984.<sup>75</sup> It is of course possible that this patent is only an improvement on a product already patented, or at least already produced. To be safe, however, a TPQ date of 1984 can be assigned to the context.

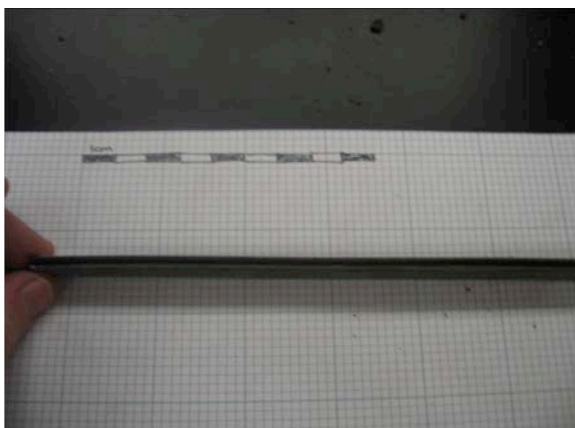

Find	Date
Mortar	
Bricks	
Red Tiles (1 cm thick)	
Green glass	
Earthenware	1490 – 1900 <sup>1</sup>
Flat Iron Pieces (architectural?)	
Cut nails	1791 – 1900 <sup>2</sup>
Plastic Report Cover Sliding Bar	1984 – present <sup>3</sup>
Slab of marble	

1 FLMNH, *Mean Ceramic Manufacturing Dates*.

2 Edwards and Wells

3 Giblin, et al., March 1986, U.S. patent number 4,575,123



[http://static.www.odcdn.com/pictures/us/od/sk/lg/429258\\_sk\\_lg.jpg](http://static.www.odcdn.com/pictures/us/od/sk/lg/429258_sk_lg.jpg)

Obviously, with the hypothesis that the architectural feature found was part of the Hale Ives House, the discovery of an artifact dating to as recent as 1984 is problematic. One potential explanation for this anomaly is that the part of the report cover was deposited during the construction of the parking lot. The destruction of the walking path (hypothesized to contain JBH 48) appears to coincide with the construction of the parking lot. However, the exact date of this change is unknown. The latest-dated map showing a proposal for the parking lot dates to 1964. However, Julie Pridham also found an undated map consistent with this 1964 map in a box whose label gave it a date range through 1988.

<sup>72</sup> Excavation form for JBH 61

<sup>73</sup> See Thelemaque, Alyssa, Object Bio

<sup>74</sup> Merillet, Marcel A., May 1970, U.S. patent number 3,513,902

<sup>75</sup> Leahy, David J., U.S. patent number 4,486,032

However, this map is most likely also from 1964, as it was drawn by the same cartographer (landscape artist James D. Graham), although it could potentially be from as late as the 1980s.<sup>76</sup>

Obviously the dates involved in this theory do not precisely line up in rational sense. Reasoning strictly from the actual evidence and assuming that the report cover does indeed correspond to the patent found (and not from an earlier patent which was merely being modified), we are forced to conclude that the parking lot was most likely built before the sliding bar report cover was invented. In this line of thinking, the report cover piece is a mysterious anomaly, which cannot be explained without further research. The TPQ provided by the report cover piece is problematic not only to JBH 61, but also to the contexts which overlie the wall feature (JBH 48 and JBH 54, which had been assigned TPQ dates of 1893 and 1900, respectively). Factoring in the time lag associated with archaeological deposits, these dates support the hypothesis that the gravel in these contexts is remnant from the gravel path which was known to be in this part of the yard during the first half of the 20<sup>th</sup> century.

### **Conclusions and Future Directions**

The excavations at Unit 6 uncovered a good deal of information about the John Brown House property. The feature discovered by Unit 5 was expanded upon, and the original hypothesis that this feature was a wall seems to be supported. At this stage it seems very likely that this wall is part of the remains of the Robert Hale Ives House. One way this excavation could be furthered is to try to excavate one of the other walls from the house, based on its probable location given by cartographic evidence and the geophysical survey done in 2008. Finding another wall could confirm that the wall we excavated was the West wall of the house (or the foundation of the West wall). Along these same lines, future excavations could attempt to follow the gravel path, to confirm that JBH 48 was indeed the path installed during the first half of the 20<sup>th</sup> century.

Our most perplexing find was the plastic report cover spine in the feature context JBH 61. Further excavation of this feature is needed in order to properly date it, and explain the spine. Additional documentary research could also potentially provide an explanation for the late TPQ date, if evidence of a possible disturbance of the feature during or after the 1980s could be found. At any rate, the anomaly is extremely perplexing and raises questions about the identification of the feature and the gravel path.

### **Works Cited**

Edwards, Jay D. and Wells, Tom. Historic Louisiana Nails: Aids to the Dating of Old Buildings. Baton Rouge, Louisiana: Louisiana State University: Geoscience Publications, 1993.

---

<sup>76</sup> Julie Pridham, personal correspondence

Excavation form for JBH 46

Excavation form for JBH 48

Excavation form for JBH 52

Excavation form for JBH 54

Excavation form for JBH 61

Florida Museum of Natural History (FLMNH). "Mean Ceramic Manufacturing Dates". Artifact Identification Guide.

Leahy, David J. "Cover Folders". U.S. patent number 6,686,032. 7 December 2009.

Merchant, Elise. "Object Biography: Plastic Bottle Cap Gasket." John Brown House Archaeological Report 2009.

Merchant, Elise. "Elise M's Field Blog." ARCH1900: The Archaeology of College Hill: 2009 Season- John Brown House. 7 December 2009.

Merchant, Elise. "Object Biography: Pencil Fragment." John Brown House Archaeological Report 2009.

Merillet, Marcel A. "Beading Device for Flexible Sheets." U.S. Patent number 3,513,902. 7 December 2009.

Nuding, Elise. "Excavation Summaries – Unit 3 and Unit 5". John Brown House Archaeological Report 2008. The Archaeology of College Hill Website.  
<<http://proteus.brown.edu/archaeologyofcollegehill/6292>>

Pridham, Julie. Personal Correspondence. 4 December 2009.

Van Melle, Hugh. "Foldback cup lid having comfortable drinking characteristics". US Patent number 5,613,619. 7 December 2009.

Yellin, Steffi. "Historical Background of the John Brown House Property". John Brown House Archaeological Report 2008. The Archaeology of College Hill Website.  
<<http://proteus.brown.edu/archaeologyofcollegehill/6292>>

## CHAPTER 6 Unit 7 Excavation Summary

Ben Colburn

Unit 7 was opened on September 4, 2009 and is a 2x1m unit along the northwest wall of the site running parallel to Benefit Street. This unit is in the same location as a 50x50cm shovel test pit (STP) dug last year and is located at N'0/W'35 with respect to the site's overall datum point (N'0/W'0). Multiple STPs were excavated last year in order to determine an appropriate area to expand on upon previous archaeological excavations conducted in the 1960's. Before placing any STPs, the team observed that from approximately N'0/W'20 to N'0/W'25, the yard exhibited a visible depression, suggesting previously disturbed soil and a likely location for the prior dig site of interest. This location was also consistent with pictures from that dig, which placed the unit of excavation approximately halfway between the John Brown House and the fence along Benefit Street (**personal correspondence with Krysta Ryzewski**). Based on the assumption that this area was the dig site and would therefore consist of backfilled soil, a decision was made to place two STPs, 5m and 10m to the west of the depression, respectively. The STP at N'0/W'30 yielded no finds of interest; however, the STP at N'35 revealed a rocky soil deposit (JBH2) adjacent to what appeared to be a man-made rock structure (Feature 1). Additionally, the team recovered several nails, what they believed to be rock stacked upon one another contiguously, and several pieces of brick and coal (**Shovel Test Pit Form, 9/8/08**). These tiles extended down as far as 60cm, the greatest depth of the STP and at the close of the 2008 field season, this STP was noted as a potential area of interest for further exploration in future field seasons. The N'0/W'35 STP is of particular interest because unlike other units, it has produced a feature that is not visible on Urban's 2008 geophysical survey as a resistive feature. This survey indicates a large resistive feature in Zone 2 along the northern border with Benefit Street; however, this STP is removed from that location and historical document analysis suggests that the indicated resistive feature is in fact the foundation of the Hale Ives House (**Yellin 30, in JBH Archaeological Report 2008**). Therefore, if we reject the hypothesis that Feature 1 is a continuation of the feature indicated in Zone 2, then the findings of this STP are puzzling. There is no evidence for a feature on the geophysical survey and yet somehow, one was discovered. In order to extrapolate upon these findings and help answer the question of just what Feature 1 is, Unit 7 was opened for excavation during the 2009 field season.



**FIGURE 1:**  
The relevant section of land from the “John Brown House Unit Locations & Quadrature Map.” Geophysical anomalies shown in blue and orange.

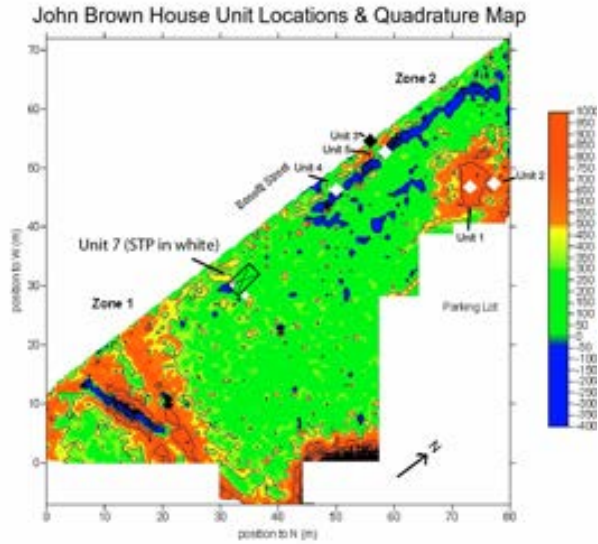

Unit 7 includes the original STP within its boundaries (in the southwest corner), but is itself a 2x1m unit that extends 2m north and 1m east of the STP. By expanding the region adjacent to the STP, we hoped to determine the borders of the uncovered feature and more precisely characterize its boundaries and relations to adjoining soil deposits. As it turns out, this decision yielded a clearly defined “rock wall” feature (Feature 3) that aligned with the long feature indicated on the geophysical survey. Although at the close of this field season, we are still unable to definitively determine what this feature might be, an intersectional analysis of material finds, structural features, soil quality, and stratigraphic evidence have enabled us to formulate two hypotheses, discussed later in this chapter.

**Methods:**

Before digging could commence, we cleared out the backfill from last year’s season in order to regain the 60cm of depth at which last year’s group closed work on the STP (**Shovel Test Pit Form, 9/8/08**). We then measured and delineated the rectangular boundaries of the unit and measured the height of each corner. Because the unit sloped slightly, the southwest corner, being the highest, was determined to be the datum point from which depth measurements would be taken. Once the corners were staked and sidewalls were demarcated with string, digging commenced in accordance with the protocols described in the introduction to this report. Artifacts were cleaned, labeled, and cataloged in the Archaeology Department laboratory at Brown. The Unit Summary has been constructed primarily from field notes taken at the time of excavation. Other sources, including written material, personal correspondence, and field blogs are cited when used.



### EXCAVATION SUMMARY:

The opening depths of the unit corners with respect to this datum point (in the southwest corner) were determined to be 3.5cm (northwest), 2.5cm (northeast), and 2.5cm (southeast) and the center depth was determined to be 3.5cm. Over the course of the 2009 field season, four contexts were assigned: JBH45 (opening), JBH50 (arbitrary), JBH51 (natural), and JBH56 (arbitrary). Opening pictures were taken before work on the unit actually began in order to formally document the initial state of the context and unit prior to excavation.



**FIGURE 2:**  
This photograph was taken of Unit 7  
before excavation commenced.

#### *JBH45:*

Unit 7 was opened on September 21, 2009 and once the turf was removed, the underlying topsoil was designated JBH45. The initial Munsell value for JBH45 range was 5YR 2.5/1 – 10YR 2/2 (dark brown) and the soil consistency was noted to be fine. These findings were consistent with those reported for the included STP, which noted a Munsell value of 10YR 2/1 throughout the STP (**Shovel Test Pit Form, 9/8/09**). This context showed a significant amount of matted roots, so the top layers of soil in this context were removed primarily by shovel shaving with the aid of root clippers.

Several artifacts of interest were detected near the bottom of JBH45, though most early finds from this context could almost exclusively be dated to the modern era without difficulty, including a dime minted in 2001, pieces of plastic children's jewelry, a cigarette filter, and chewing gum foil. The only

immediately recognizable historic artifacts found in JBH45 were a small creamware sherd, a medium-sized sherd of redware that retained sections displaying a characteristic apple green glaze and a hand-painted piece of porcelain displaying red enamel flourish designs which was later identified as Imari porcelain. For more information on these objects, see the Object Biography by Ben Colburn. Based on the discovery of the 2001-minted dime, the TPQ (*terminus post quem*) was assigned to be 2001.

**TABLE 1:**  
Temporal Dating for Artifacts found in JBH45

<b>JBH45:</b>	<b>Column1</b>	<b>Column3</b>
<b>Item</b>	<b>Number</b>	<b>Date Range</b>
<i>Cigarette filter</i>	1	1954-p <sup>1</sup>
<i>Green elastic/nylon hair tie</i>	1	1935-p <sup>2</sup>
<i>"Dogs Own" plastic</i>	1	1855-p <sup>3</sup>
<i>Hard plastic pieces</i>	6	1855-p <sup>3</sup>
<i>Imari porcelain sherd</i>	1	
<i>Clear glass sherds</i>	3	
<i>Round-head 4.5" wire nail</i>	1	1880-p <sup>5</sup>
<i>SOLO cup fragment</i>	1	1970-p <sup>6</sup>
<b><i>Dime (minted 2001)</i></b>	<b>1</b>	<b>2001</b>
<i>Apple green glaze redware sherd</i>	1	1490-1650 <sup>4</sup>
<i>UID rusty nail fragment</i>	1	
<i>Creamware sherd</i>	1	1762-1820 <sup>4</sup>
<i>Mint chewing gum in foil wrapper</i>	1	1914-p <sup>7</sup>

Table 1 Sources:

<sup>1</sup>CNN, <http://www.cnn.com/US/9705/tobacco/history/>

<sup>2</sup>Plastics Historical Society, [www.plastiquarian.com](http://www.plastiquarian.com)

<sup>3</sup>Wikipedia

<sup>4</sup>Florida Museum of Natural History (FMNH), *Mean Ceramic Manufacturing Dates*

<sup>5</sup>Harp Gallery, <http://www.harpgallery.com/library/nails.htm>

<sup>6</sup>SOLO Cup Company History,

<http://www.solocup.com/soloabout/aboutHistory.html>

<sup>7</sup>Idea Finder ("Chewing Gum"), <http://www.ideafinder.com/history/index.html>

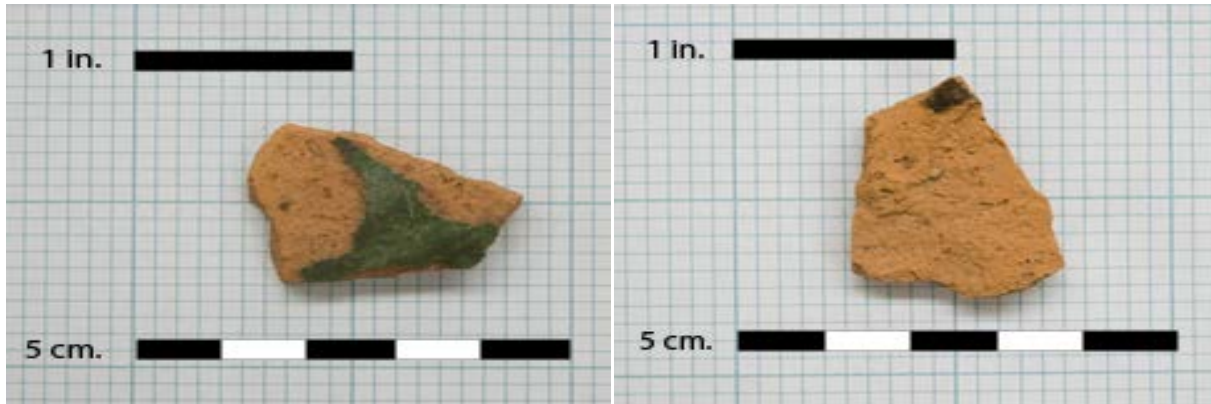

**FIGURE 3:**  
Front (left) and back (right) views of the Green-Glazed Redware Sherd. For more information, see the Object Biography by Ben Colburn

*JBH50/JBH51:*

During the excavation of JBH45, a two separate sediment patterns were observed to effectively bisect the unit into an eastern context (JBH50) and a western context (JBH51). The dirt remained consistent throughout the unit as measured by Munsell readings; however, the western half of the unit showed an increasing prevalence of small rocks and the overall sediment character slowly came to more closely resemble gravel than fine dirt. The border between this sediment character and the rest of the context was unclear at first; however, it was noted that the gravel seemed to be found only on the same side of the unit as the STP, in which significant rock structures were detected at greater depths.

As the border between the gravel on the western side of the unit and topsoil on the eastern side became more pronounced, two new contexts were established below JBH45. At corner depths of 8cm (northwest), 9cm (northeast) and 5.5cm (southeast) and a center depth of 10.5cm, JBH50 was opened as an arbitrary context after 10cm of excavation in JBH45, per our team's policy. Additionally, JBH51 was opened at the same depth to include the gravelly half of the unit and differentiate between these soil conditions as a significant find.

At the time of context designation for JBH50 and JBH51, a line of several protruding rock were noted to clearly delineate the difference in sediment patterns between contexts. Although this phenomenon had not formally been assigned as a feature yet, it was treated as a reference point for the border between

contexts. As JBH50 gained additional depth and more of these rocks became visible, this border became increasingly clear and was designated as a man-made feature (Feature 3).

**FIGURE 4:**  
A sketched plan view showing the emergence of Feature 3 and its usefulness in dividing JBH50 and JBH51 (JBH51 Excavation Form, 2009)

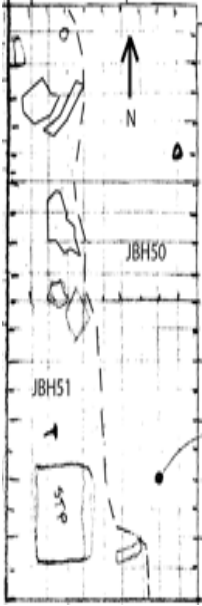

Throughout its excavation, JBH50 exhibited no changes in soil consistency or color and was treated as part of the same stratum that included JBH45 above it. In the first week of work in JBH50, a very small mustard-yellow sand deposit was detected near the southern end of the east wall, but it was very small and did not protrude into the unit beyond the wall. Consequently, it was not included as part of Unit 7 and we decided not to classify this soil change as a new context.

In the absence of any structural features, work in JBH50 proceeded relatively quickly and shovel-shaving was used as a primary tool to acquire the depth required to open a new arbitrary context. JBH50 yielded several finds of interest, including sherds of creamware, porcelain, pearlware, whiteware, colored glass (aqua and clear), rusted nail fragments, and shell. Two creamware pieces were functionally (though not temporally) diagnostic based on rim sizes and suggest the presence of: (1) 6-7" clear-glazed creamware plate. Other pieces were temporally diagnostic based on the presence of well-documented glazing patterns and/or image motifs, including porcelain with a red hand-painted image and clear-glazed pearlware with an underlying hand-painted blue image. Additionally, we found a hollowed cylindrical ceramic piece that was identified as part of a tobacco pipe stem. Based on measurements of its internal diameter (a well-documented and temporally diagnostic feature), we suggest that this pipe stem was made between 1720 and 1760 (for more information on the Ceramic Pipe Stem, see the Object Biography by Sarah Baker). Both of these dates are post-dated by multiple objects, but the discrete production period indicated for the pearlware sherds sets the TPQ for this context at 1840.

<b>JBH50:</b>	<b>Column1</b>	<b>Column2</b>
<b>Item</b>	<b>Number</b>	<b>Date Range</b>
General Creamware	14	1760-1820 <sup>1</sup>
Creamware 6-7" plate	1	1760-1820 <sup>1</sup>
General Porcelain	1	
		1700-1750 <sup>1</sup> (Imari)
Porcelain w/ red hand-painted	1	1700-1780 <sup>1</sup> (Ching polychrome)
Porcelain w/ general floral	1	1550-1644 <sup>1</sup> (Ming, blue on white)
<b>General Pearlware</b>	<b>2</b>	<b>1780-1840<sup>1</sup></b>
<b>Pearlware with blue handpainted</b>	<b>1</b>	<b>1775-1840<sup>1</sup></b>
General Whiteware	3	1830-p <sup>1</sup>
Coal	23	1784-p <sup>2</sup>
Ceramic Pipe Stem, 5/64 <sup>th</sup>	1	1720-1750 <sup>3</sup>
UID nail fragments	5	
Aqua glass	9	
Clear glass	1	

**TABLE 2:**  
Temporal Dating for Artifacts found in JBH50

**TABLE 2 (cont'd):**  
Temporal Dating for Artifacts found in JBH50

Bone fragments	2	
White quartz sherds	2	
Rubber piece (not vulcanized)	1	<b>1837-p<sup>4</sup></b>
Gray stoneware fragment	1	
Shell pieces	3	
Brick chunks	12	
Rusted metal hardware	1	

*Table 2 Sources:*

<sup>1</sup>Florida Museum of Natural History, Mean Ceramic Manufacturing Dates

<sup>2</sup>National Energy Technology Laboratory,

<http://www.netl.doe.gov/KeyIssues/historyofcoaluse.html>

<sup>3</sup>National Park Service,

[http://www.nps.gov/archeology/afori/howfig\\_mar4.htm](http://www.nps.gov/archeology/afori/howfig_mar4.htm)

<sup>4</sup>About.com, "Charles Goodyear"

<http://inventors.about.com/od/gstartinventors/a/CharlesGoodyear.htm>



**FIGURE 5:**

Side view of the Ceramic Pipe Stem. For more information, see the Object Biography by Sarah Baker.

JBH51 also yielded several significant finds, most notably Feature 3. Although part of this feature had already been discovered and used to differentiate between JBH50 and JBH51, continued excavation in JBH51 revealed the presence of a significant number of large rocks that appeared to have been adhered together or else unnaturally deposited together. As the first signs of these rocks were detected (as protrusions), the team discontinued shovels within the context and switched over to the exclusive use of trowel sand brushes. Because excavation in JBH51 proceeded more slowly in order to maintain the

integrity of Feature 3, the context yielded significantly fewer artifacts than adjacent contexts. This lack of finds is primarily due to the fact that less depth was attained and the majority of the context was obstructed by Feature 3. Some early finds included rusty cut nail fragments (and one complete nail), several pieces of mortar, a rusty piece of metal scrap, and small- to medium-sized chunks of brick. The frequency of mortar chunks increased dramatically in the southwest corner of the context and consequently, a few samples were saved for analysis and the rest were discarded. One find of particular note and potential diagnostic value in this context was a small number of worked white stones resembling tiles. They showed clear signs of having been worked by humans, but it was impossible to assign any temporal range to their production.

**TABLE 3:**  
Temporal Dating for Artifacts found in JBH51

<b>JBH51:</b>	<b>Column1</b>	<b>Column3</b>
<b>Item</b>	<b>Number</b>	<b>Date Range</b>
Red brick chunks	28	
Handmade nail	1	
Mortar pieces	11	
White marble "tiles"	13	
<b>Cut nail fragments</b>	<b>8</b>	<b>1818-1890<sup>1</sup></b>
White quartz chunks	7	
Cut stone	1	

*Table 3 Sources:*

<sup>1</sup>Historic Louisiana Nails, Jay D. Edwards and Tom Wells (1993)

One find from JBH51 was noted in lab to belong to another context. A wadded up piece of chewing gum in its foil wrapper was discovered in the JBH51 finds bag and, had it been included as a find in this context, would have dramatically altered the context's TPQ; however, multiple group members remembered recovering this artifact from JBH45, so it was reassigned to that context. Minus this object, the only temporally diagnostic find recovered from JBH51 were the cut nail fragments, which make the TPQ for this context 1890.

In the process of excavating the areas around the individual rocks comprising Feature 3, a large hole was detected between rocks. This find indicates that at least one of the contiguous rocks was deposited separately from the wall and that not all rocks in the context are in fact associated with the feature as it

once existed. Instead, we can interpret these loosely associated rocks as coincidental discoveries that are the consequences of environmental forces of deposition. Therefore, rocks not intimately associated with the feature via tight junction to one or more large rocks were removed from the context without analysis. Additionally, several rocks deemed to be a part of Feature 3 were also removed in order to permit further excavation. Unlike rocks unassociated with the feature, these rocks were measured and documented appropriately before being discarded. As the season came to a close and work on JBH51 became more tedious, it was abandoned in order to focus more time and energy on increasing the depth of the rest of the unit.

*JBH56:*

At a uniform depth of 24cm in JBH50, a new arbitrary context JBH56 was opened. This would be the last context opened in Unit 7, as time constraints forced us to end the field season before a new context (either natural or arbitrary) could be designated. In the preceding week, rains had muddied the soil and made excavation more difficult and consequently, depth measurements revealed that JBH56 was actually opened below the designated depth for the opening of a new arbitrary context; however, because the soil character of JBH56 still appeared to be consistent with that JBH50, this discrepancy was overlooked and the context was opened at its measured depth.

The soil color and consistency in this context were determined to be identical to JBH50 and JBH46 and this character remained constant from the opening of this context until the end of the season. In the absence of any significant features at the opening of JBH56, it was excavated using shovel-shaving as a primary means to acquire greater depth quickly and efficiently. During this process, several artifacts of interest were recovered, including many colors of glass (clear, aqua, light green, and dark olive green), rusty nail fragments, pieces of coal, sherds of pearlware, whiteware, porcelain, creamware, and redware, pieces of red brick, a piece of slag, shell fragments, and traces of mortar. No functionally diagnostic pieces were found, though many other pieces were temporally diagnostic based on the presence of well-documented glazing patterns and/or image motifs, porcelain with a crude floral print, Cantonware (porcelain), creamware with a red handpainted image, and clear-glazed pearlware with an underlying hand-painted blue image. No detectibly modern artifacts were recovered. Therefore, based on the diagnostic information available from artifacts in this context, its assigned TPQ is 1840.



**TABLE 4:**  
Temporal Dating for Artifacts found in JBH56

<b>JBH56:</b>	<b>Column2</b>	<b>Column3</b>
<b>Item</b>	<b>Number</b>	<b>Date Range</b>
UID rusty nail fragments	4	
Dark olive green glass fragments	3	
Light green glass sherds	2	
Aqua glass fragments	6	
Clear glass fragments	3	
<b>Pearlware sherds with blue hand-painted image</b>	<b>2</b>	<b>1775-1840<sup>1</sup></b>
<b>Pearlware sherds</b>	<b>2</b>	<b>1780-1840<sup>1</sup></b>
Whiteware sherd with green hand-painted image	1	<b>1830-p<sup>1</sup></b>
Whiteware sherds	4	<b>1830-p<sup>1</sup></b>
Crude floral porcelain sherd	1	<b>1550-1644<sup>1</sup> Ming, blue on white</b>
Cantonware porcelain sherd	2	<b>1790-1835<sup>1</sup></b>

**TABLE 4 (cont'd):**  
Temporal Dating for Artifacts found in JBH56

Coal	17	<b>1784-p<sup>2</sup></b>
		<b>1762-</b>
Creamware sherds	10	<b>1820<sup>1</sup></b>
		<b>1700-</b>
Redware sherd with dark brown lead glaze	1	<b>1770<sup>1</sup></b>
		<b>1500-</b>
Unglazed redware sherds	13	<b>1750<sup>1</sup></b>
Red brick chunks	3	
Slag piece	1	
Shell	1	
Mortar flecks		
Unidentified pieces of rust		

*Table 4 Sources:*

<sup>1</sup>Florida Museum of Natural History, *Mean Ceramic Manufacturing Dates*

<sup>2</sup>National Energy Technology Laboratory,

<http://www.netl.doe.gov/KeyIssues/historyofcoaluse.html>

Later excavation in JBH56 revealed a sprinkler hose running east to west approximately 30cm from the north wall. Although this find was not catalogued as a feature when it was discovered (the last day in the field), it was retroactively designated Feature 4. Interestingly, this feature projects straight through Feature3, yet does not seem to have disrupted it significantly. Additionally, it is the only modern object found in JBH56, yet it could not possibly have been deposited at the same time as other finds in the context. The incongruence of this feature with the majority of artifacts recovered from the context in which it was discovered suggests it was introduced to this context after sediment was laid down. It is highly likely that this phenomenon can be explained, as Alex Knodell has suggested that the hose was installed at its current depth by dragging it through the yard at that depth using a modern landscaping technology (**personal correspondence with Alex Knodell**). Since Feature 3 was surrounded by

compact natural sediment to bolster its structure, it is therefore possible for the hose to have also been dragged through the feature when it was laid down without significantly disturbing it. Since there is no evidence to corroborate a similar temporal range of deposition in the John Brown House records, we must conclude that indeed, Feature 4 was introduced to Unit 7 after the original sediment was laid using modern landscaping techniques.

**FIGURE 7:**  
A sketch of Unit 7 at the close of the 2009 field season

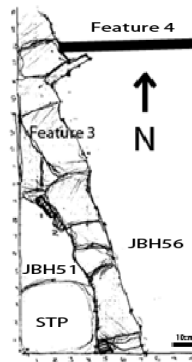

#### ANALYSIS:

##### **Features:**

Unit 7 revealed two features: Feature 3 and Feature 4. Although these features physically intersect, we believe their relationship is easily explained. Based on the discussion above, we believe Feature 4 (a sprinkler hose) was inserted through Unit 7 after the soil in which it was found (JBH56) was deposited. This theory is also consistent with the visible landscape of the John Brown House yard. Specifically, Feature 4 runs parallel to N'0 from east to west, along the same line that was used to determine locations for STPs. At the site of the depression mentioned earlier in this report, there is also now a drain. The direction of the pipe and its intersection with this drain suggest that together, these function as a drainage and/or irrigation system for the yard. With respect to this archaeological dig, this conclusion leads us to believe that Feature 4 is not historically significant.

Feature 3, however, is a more complex issue altogether. As was discussed earlier, Urban's 2008 geophysical survey of the John Brown Yard does not indicate any significant resistive features in the region of Unit 7. Therefore, its discovery in last year's STP was quite accidental and perplexing. Two hypotheses currently exist to functionally explain Feature 3. The first hypothesis suggests that the rocks dividing JBH50 and JBH51 are part of a "stone wall" and hence, represent one wall of a larger structure's foundation. The second hypothesis, postulated by Alex Knodell as the "walking path" hypothesis, suggests that the stones are not a wall at all, but are instead the marked edge of a walking path (personal correspondence with Alex Knodell).

Although we cannot find any historical documentation to verify (or reject) either hypothesis, they can both be supported based on the documented history of the yard. A schedule of John Brown's personal estate (c. 1803) indicates that his property contains not only a main house, but also "outhouses, viz. Coach-house, kitchen, stable, and Wood-house, with the bathing house," which might suggest that Feature 3 is indeed part of one of these outhouses. However, the same document also confirms the presence of "paved yard," which we can interpret to mean a delineated path (**Brown Estate Schedule, 1803**).

Additionally, a survey of maps depicting the John Brown House reveals that between 1921 and 1926, the Hale Ives House (whose foundation is prominently featured in Zone 2 of the geophysical survey), was demolished. An interview with Marsden Perry reveals that indeed, he "demolished the old homestead of Robert Ives Gammell and made the lawns of the two adjoining estates into a beautiful lawn such as is now a part of the John Brown Mansion estate lands (**as cited on Yellin 32-33, JBH Archaeological Report 2008**)." If Feature 3 was indeed an outhouse, it may well have been demolished around the same time as the Hale Ives House. This explanation of Feature 3 could potentially account for large contiguous strata that spanned all Unit 7 contexts and contained approximately the same types of artifacts (save the topsoil, which contained more modern objects).

Feature 3 may also make more sense as an outhouse than a paved path simply because of the artifacts it contained. If Feature 3 was a paved path, then the presence of a plate and other exotic ceramics (e.g. likely imported porcelain) are more difficult to explain than if they were simply remnants from a lived-in outhouse. Unfortunately, if Feature 3 were indeed part of the foundation for a larger outhouse's structure, we must be even more critical of its absence on the geophysical survey, since the Hale Ives House foundation showed up so clearly. Perhaps this means the outhouse was very small, but we must also take note of the fact that the stones uncovered in Feature 3, though artificially articulated, are not of the same size or type as those seen in other Units last season. Whereas Unit 5's foundation stones were large and thick, the stones found in Feature 3 are small and flat. Therefore, Feature 3 does not appear consistent with the existing documented foundation types at the John Brown House and is suspect as the remnant of an outhouse structure.



**FIGURE 8:**  
A contrast between the stones of Feature 3 (left) and those found in Unit 5 from the Hale Ives House(right)

***Strata, Contexts, and Soil:***

Moreover, the soil in all Unit 7 contexts was found to be identical, with an estimated Munsell range of 5YR 2.5/1 – 10YR 2/2 (dark brown). One natural context was documented (JBH51) but even this context maintained the same soil color despite changes in sedimentary composition. Therefore, we have concluded that for all four contexts excavated in Unit 7 this field season, only one stratum exists (Stratum 1). This is corroborated by analysis of the unit walls, which show no remarkable changes in soil color or consistency, aside from the one already accounted for via the designation of JBH51. In order to provide a clearer illustration of the order of context designation and excavation in general, we have organized all excavated contexts into a Harris matrix, provided below:

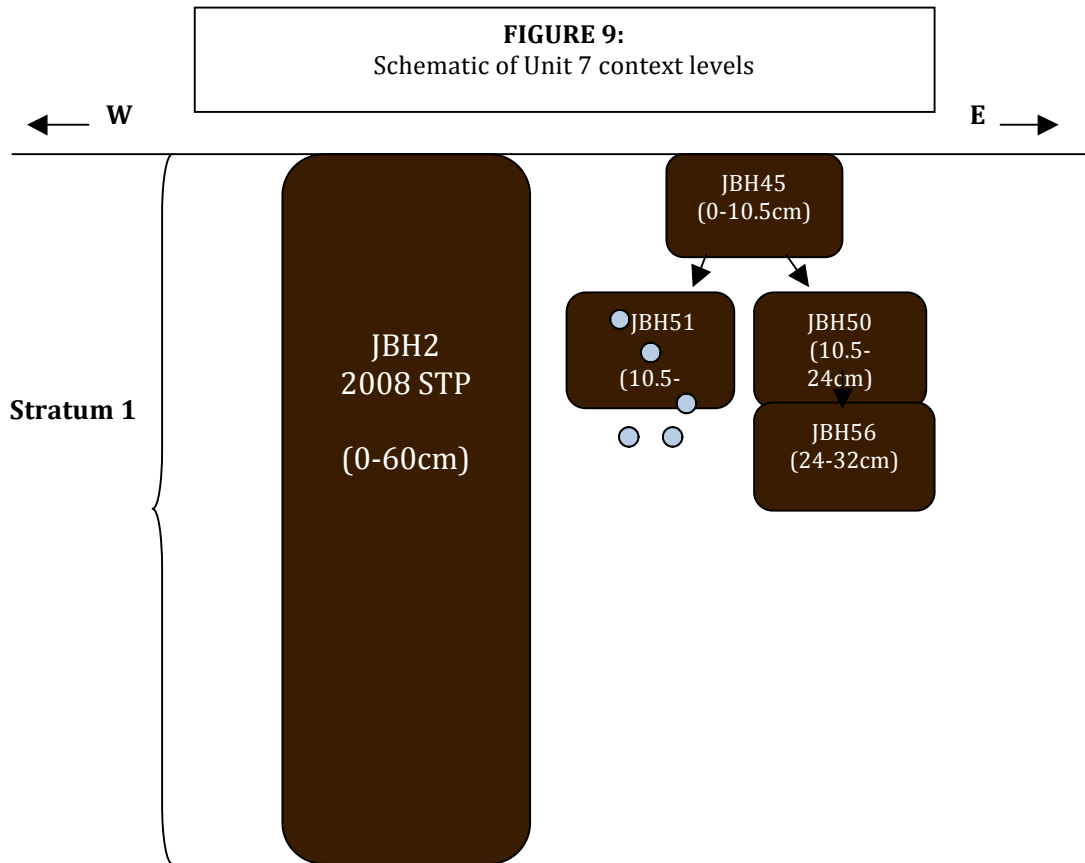

**Timeline for Deposition:**

Because stratigraphic analysis does not reveal distinct strata within Unit 7 to date, we must rely on *terminus post quem* (TPQ) analysis and artifact analysis in order to determine the timeline for deposition. The TPQ represents the earliest possible date that a context could have been deposited and is determined by analyzing the temporal dates for every artifact it contains. The TPQ is valuable because by determining the last object to be deposited, we can effectively date every context. Because modern objects were deposited in most contexts and our primary time of interest is significant earlier, we will use TPQ analysis to determine the latest date of artifact deposition rather than *terminus ante quem* (TAQ) analysis, which aims to isolate the first artifact deposited. We know that Providence, RI was settled by Roger Williams in 1636, this date will serve as our default TAQ until indicated otherwise.

Given the TPQ dates for each context listed below, it appears that Unit 7 conforms to a classic timeline for deposition, with the first contexts reached (e.g. JBH45) being the youngest and the last to be reached being the oldest (e.g. JBH50, JBH56). In summary, JBH56 was deposited first, then JBH50 and JBH51, and lastly, JBH45. Although we cannot compare this reading to a stratigraphic analysis (since all contexts are

theorized to be contained within the same stratum), this artifact analysis is the best guess we can make at this point about the temporal relationship of these contexts.

At present moment, it is difficult to confidently assign a representative TPQ date to JBH51 because of its relative paucity of temporally dateable artifacts. As will be discussed later, for this reason, we recommend an westward expansion of Unit 7 in order to provide a more accurate picture of this portion of Stratum 1 for more confident dating.

**TABLE 5:**  
TPQ Analysis for dateable artifacts in contexts JBH45, JBH50, JBH51, and JBH56

<b>Context</b>	<b>Artifact 1</b>	<b>Artifact 2</b>	<b>Artifact 3</b>	<b>TPQ:</b>
JBH45	Cigarette filter (1954-p)	SOLO cup fragment (1970-p)	2001-minted dime (2001)	<b>2001</b>
JBH50	Whiteware (1830-p)	Unvulcanized rubber (1837-p)	All pearlware (1775-1840)	<b>1840</b>
JBH51	Cut nail fragments (1818-1890)	---	---	<b>1890</b>
JBH56	Cantonware porcelain (1790-1835)	Whiteware (1830-p)	All pearlware (1775-1840)	<b>1840</b>

**A Note on Artifacts:** Object biographies were completed for the Green-Glazed Redware Sherd, the Imari Porcelain Teacup Sherd, the English Soft-Paste Porcelain Saucer Sherd, the Ceramic Pipe Stem, the Cantonware Sherd, the Handmade Nail, the 2001-minted dime, the SOLO cup fragment, or the Wire Nail please consult Part II of this report.

#### **CONCLUSION:**

Despite its relative invisibility on Urban’s 2008 geophysical survey, Unit 7 has revealed a significant structural feature of unknown identity that merits continued excavation. To date, no historical analysis of primary documents has revealed any significant leads on just what Feature 3 might be, although multiple primary sources indicate that Feature 3 is almost definitely not contiguous with the Hale Ives House foundation north of Unit 7. Despite this lack of evidence, the current “stone wall” and “paved path” hypotheses are supported by the little historical documentation we do have for the area. JBH56, one of two closing contexts in Unit 7, has yielded evidence of interaction with artifacts from the time period of interest in the John Brown House’s history in the form of temporally diagnostic ceramic sherds. The other closing context JBH51 was not worked extensively because Feature 3 and the gravelly soil on its western side made excavation exceedingly difficult. JBH51 was closed as a relatively higher

depth than JBH56 and its failure to produce temporally dateable or historically significant artifacts should be considered as a likely consequence of its shallow depth rather than a representative depiction of its contents and the contents of the contexts below it.

In order to more precisely determine the identity of Feature 3, we recommend that future archaeological work at the John Brown House continue excavation on Unit 7 and expand its western wall in the hopes of more precisely defining the boundaries of JBH51 with relation to surrounding soil deposits. Until such an excavation is undertaken, relatively little can be asserted about the historical significance and functionality of Feature 3 and the surrounding soil deposits in Unit 7.

#### **WORKS CITED:**

ARCH 1900 Field Notes. Fall 2008.

ARCH 1900 Field Notes. Fall 2009.

Brown Estate Schedule (1803). Available at: <http://proteus.brown.edu/archaeologyofcollegehill/6499>  
"Excavation and Unit Summaries". Archaeology of College Hill.

<http://proteus.brown.edu/archaeologyofcollegehill/6346>.

Knodell, Alex. Personal correspondence. November 2009.

Ryzewski, Krysta. John Brown House Archaeological Report 2008. Available at:

<http://proteus.brown.edu/archaeologyofcollegehill/Home>

Ryzewski, Krysta. Personal correspondence. November 2009.

Urban, Thomas M. *John Brown House Preliminary Geophysical Survey Report*. 2008. Available  
at: <http://proteus.brown.edu/archaeologyofcollegehill/7043>.

**\*NOTE: Citations for artifacts provided below their respective tables**



## CHAPTER 7 Unit 8 Excavation Summary

Andrew Seiden

Unit 8 was a completely new plot, and was not based around any kind of previous geophysical survey. It does not appear on the original geophysical map made at the start of the 2008 season. Thus, unlike the other units near the Ives House area lower in the yard, the excavators of Unit 8 began with a full square of topsoil and grasses, with no reference (such as a shovel test pit or previous season's unit contained within the 2009 season unit) to previous excavations or to what they were expected to find. This of course, had its positives and negatives. The group did not benefit from a constant straightforward goal, such as continuing to excavate a hypothesized stone foundation wall, but was able to construct its own goals and ideas based on interesting finds. There was a lot of speculation during the excavation process itself, as to what the finds meant, and as to what could exist deeper in the soil.

### Location

Unit 8 is Located next to the old wood sheds behind the house, and the newer additions to the house made by Perry. Units 8 and 9 are elevated above the rest of the JBH yard, and the other two units. It is on a small gradient, unlike the other units, which are more or less flat.

The unit is 2x2 m, a relatively large size, especially for a team of three. The team consisted of Laura Sammartino, Sarah Roberts, and myself, with Krysta Ryzewski, Alex Knodell, and Elise Nuding supervising and constantly offering a helping hand. It had to be larger in size because we were beginning to uncover a completely new area and needed a wide space to make certain nothing was missed.

One of the main reasons for digging at this location is the potential construction of a new geothermal well as a “cost effective, reliable, sustainable, and environmentally friendly”<sup>77</sup> method of providing heat to the John Brown House area. In this sense, we were conducting a kind of “rescue archaeology” in that we were going to see if there were any notable discoveries that could be made about the area surrounding the house, where the outhouses, kitchens, stables and servant working areas would have been.

Trends in current archaeology tend to focus more on the daily lives of normal people, who give a better sense of the general lifestyles of the time than the rich, whose houses and possessions have been more easily preserved because of their monetary, sentimental, and historical value. In this regard, the John Brown House Museum is certainly no exception; the lives of the Brown family are well documented and the inside of the house, including bedchambers, parlors, and guest spaces are accurately reconstructed and furnished. But the servants' quarters and outbuildings where they would have spent much of their time are only depicted in a handful of drawings and lists. Like Mrozowski's Living on the

---

<sup>77</sup> Wikipedia Online Encyclopedia

Boott, the Archaeology of College Hill field course focused its attention on the yard in the back of the house, where it is expected that the tasks of daily life and labor would have been performed, but have yet to be substantially recognized through the historical record.<sup>78</sup>

### JBH 43

Context JBH 43 was our surface context. As pictured below, there was a decent amount of grass and root coverage that had to be cut and removed before actual digging could take place.



The initial elevation measurements were based off of the highest point, which was the northeast corner of the unit. As was noted, the unit exists on a small incline, so the starting heights vary. See below for the depth ranges of JBH 43.

Pointed shovels and clippers were used to remove roots, grasses, and weeds from the surface of the unit. This was done carefully; the roots were cut not pulled up, because shifting roots and soil underground, depending on the depth, could have potentially displaced or changed the orientation of the artifacts below.

Despite the shallow depth of the surface unit, we quickly began to find small artifacts and fragments in the sifted soil. Some of the many finds from this context are: coal, brick, glass, duct tape, wire nails, a piece of upholstery tack metal, redware

#### Depth Measurements: JBH 43

NW: 12.5 – 14cm  
\*NE: 2.5 – 8cm  
SE: 7.5 – 8cm  
SW: 14.5 – 17.5cm  
Center: 10.5 – 11cm

\*datum point

<sup>78</sup> Mrozowski, 1996.

fragments, a piece of slate roof, paint chips, porcelain, and a plastic pipe saddle. See below for a list of dated artifacts.

**JBH 43**

<b>Artifact Description</b>	<b>Production Range (years)</b>
Unglazed Redware Rim of Large Pot	1725 – present, (Stelle, 2001)
Rusted Wire Nails	1890 – present (Stelle, 2001)
Canton Porcelain Plate Fragment	1790 – 1835, (FLMNH)
Chinese Porcelain (Blue Spearhead Border)	1730-1780
Pipe stem	1750-1800
Creamware	1760 -1820, (Stelle, 2001)
Pearlware with Blue Shell Edge	1825-1891, (Stelle, 2001)
Stoneware Fragment (Bellarmine Vessel)	1550-1725
Pipe Saddle	1988 - present
Duct Tape Piece	1942-present, (Ament, 2006)
Orange Plastic Pieces	1909-present, (Bellis)

Of note is the range of dates; this context, as we will see is the case for the entire unit, is full of both colonial artifacts from the eighteenth and nineteenth centuries and modern manufactured pieces. The existence of a plastic ‘pipe saddle’ and duct tape fragments alongside Chinese porcelain and stoneware from a Bellarmine vessel makes for a somewhat confusing conception of the order of deposition.<sup>79,80</sup>



**JBH 49**

JBH 49 was established below JBH 43 because of a natural soil change. The soil of this context was a mottled gray-brown color with orange and green silty patches, but constant wetness of the soil made it difficult in future contexts to provide accurate Munsell data.<sup>81</sup> JBH 49 also contained more numerous and more sizeable rocks than the previous context did.

No architectural features were found in this context,

Depth Measurements: JBH 49  
 NW: 14 – 34cm  
 \*NE: 8 – 23cm  
 SE: 8 – 20cm  
 SW: 17.5 – 27.5cm  
 Center: 11 – 26.5cm  
 \*datum point

<sup>79</sup> Roberts, Sarah. Object Biographies.

<sup>80</sup> Mittman, Alexander. Object Biographies

<sup>81</sup> Sammartino, Laura. “Laura’s Field Blog.”

though there were signs of architectural construction. Pieces of cut metal, slate, coal, brick fragments, and pieces of mortar were unearthed. At the time of excavation, we believed that the prevalence of these construction materials could be due to the unit's proximity to the newer additions to the house, and could have been remnants of that construction. As we will see, however, the unit's proximity to the house may not have been a very important factor in the makeup of the artifact remains.

In addition to the construction materials, there were many artifacts recovered, including various porcelain, whiteware, and pearlware fragments. For a list of dated artifacts retrieved from this context, including a plastic coffee cup lid piece that served as the context's TPQ (Terminus Post Quem) date, see below.



**JBH 49**

Artifact Description	Production Range (years)
Brown Colored Transfer Print Whiteware Fragment	1829-1850 (Stelle, 2001)
Various Types of Porcelain	1700 – 1835 (FLMNH)
Creamware	1760 -1820, (Stelle, 2001)
Pearlware	1780 – 1840 (FLMNH)
Plastic Coffee Cup Top	1909-present, (Bellis)

The excavators used a shovel-shaving technique with flat shovels, and used trowels to remove sediment from the unit. Group members at this point began to notice that in the southeast corner of the unit, there was an L-shaped patch of darker, finer soil. This patch would become context JBH 58 or Feature 1.<sup>82</sup>

**JBH 57**

What began as an arbitrary context change from JBH 49 based solely on depth became one of the most fruitful contexts in terms of artifact and architectural discoveries.

<sup>82</sup> Sammartino, Laura. "Laura's Field Blog."

**JBH 57**

<b>Artifact Description</b>	<b>Production Range (years)</b>
Creamware	1760 -1820, (Stelle, 2001)
Pearlware	1780 – 1840 (FLMNH)
Whiteware	1820 – present
Chinese Porcelain with Gold Rim	Unknown
Porcelain Fragments, Korean Plum Blossom	Unknown
European Soft Paste Porcelain	1745 – 1800 (FLMNH)
Brown Colored Lead Glazed Redware	1725 – present (Stelle, 2001)
Large Red Ceramic Drainpipes and Fragments	Unknown
1946 Wheat Penny	1946-present
Duct Tape Piece	1942-present, (Ament, 2006)
Torn 'Twix' Candy Wrapper (with website)	Contemporary

Located below JBH 49, and encompassing the entire unit except for JBH 58 (feature 1) in the southeast corner, JBH 57 is defined, but not solely, by the uncovering of a gray cloth tarp found to underlie almost the whole unit. The soil above this tarp is considered JBH 57, while the gravel below it becomes a new context, JBH 62.

Some other interesting finds from this context are a pair of large terra cotta drainpipe segments (one of which is pictured below), pieces of creamware, pearlware, whiteware, and Chinese and European porcelain fragments.

**Depth Measurements: JBH 57**

NW: 34 -  
 \*NE: 23 -  
 SE: 20 -  
 SW: 27.5  
 Center: 26.5 – 40cm

\*datum point





Again, there was this mixture of historical artifacts and contemporary artifacts: there were these earthenware shards, as mentioned, and also pieces of duct tape and part of a Twix candy bar wrapper.



Note that the candy wrapper fragment advertises the company's website, and thus can be placed in a contemporary context. See the chart for production ranges for dated items.

Since the two terra cotta drainpipe fragments were found perpendicular to one another, and were each situated parallel to the unit's walls (one near the south wall and one near the east wall, it is one hypothesis of the group that these heavy drainpipe segments were used to weigh down the cloth tarp when it was initially placed on top of the gravel deposit.<sup>83</sup> Therefore it is possible that the soil and artifacts found in JBH 57, as well as the above contexts, were then deposited over the tarp intentionally to cover it up. This is interesting because in this case, the sediment deposition is opposite to a natural type of deposition, in which the deepest layers would automatically be the oldest. Here, there is the possibility that the upper contexts, containing mixed contemporary and historical artifact remains, are older than the gravel fill and tarp that lays beneath it.

### **JBH 58**

JBH 58 is our Feature 1, located in the southeast corner, is an L-shaped intrusion of dark brown fine soil. Here you can see it outlined.

---

<sup>83</sup> Seiden, Andrew. Object Biographies.



There were very few artifact finds in this context, but the fine soil made it easier to sift them out. Two of the dated finds are listed in the chart for this context.

<b>JBH 58 (Ft. 1)</b>	
<b>Artifact Description</b>	<b>Production Range (years)</b>
Creamware	1760 -1820, (Stelle, 2001)
Cut Nails	1790-1830, (Stelle, 2001)

In regard to the limits of this context, the group was undecided on how far Feature 1 really extends. The feature definitely exists through multiple of our contexts, and was not labeled a separate context until we had exposed some of it already. It is possible that some of JBH 58 soil was mistakenly sifted and labeled as JBH 49 and/or JBH 57.

It is also possible that this context extended further toward the west wall, along the southern border of the unit, as it can be seen in the southern wall profile picture.



Notice that Feature 1, the dark soil on the left, may have extended past the middle segment of lighter soil, to the right (west) side of the unit as well. But this is not accounted for in the excavation data, as it was not recognized until later. There is also another terra cotta pipe shard that sticks out of the south wall right in the center of the unit, so it was hypothesized that the pipes segments were installed for drainage purposes and that perhaps JBH 58 and this finer darker soil is the remnants of that installation.<sup>84</sup> Therefore, it would be newer than the other contexts around it, even though it is underneath them. All in all, the stratigraphy of Unit 8 is a bit shaky.

## **JBH 62**

JBH 62 consists of everything underneath the cloth tarp, which was, to our knowledge and the extent of our exploration, simply gravel with minimal artifact deposits. See the photograph below of the southern edge of the gravel deposit, with the cloth tarp pulled back.

---

<sup>84</sup> Seiden, Andrew. Object Biographies.





Unfortunately, the group did not fully expose the surface of the tarp until the last half hour of the last day of excavations, so our experience with this context is quite limited but it is of primary importance in analyzing the contents of Unit 8, and drawing conclusions.

After peeling back the tarp in the south section, we utilized the remaining twenty or so minutes to frantically search for the bottom of a homogenous gravel, which, like sand, continually replenished itself from the edges of the hole we were creating. Concentrating on only the southwest edge (20 cm from the south wall), where the gravel met the soil and perceivably was the end of the deposit, we dug to an approximate depth of 72 cm (from the datum point) without hitting anything but gravel before it was time to backfill the whole unit and end the excavation portion of the course.

The one artifact from this context is a clear plastic mesh piece of unknown origin or use (we called it a 'nozzle' at the time of the find)<sup>85</sup> but which places the context in the realm of the contemporary and thus newer than some of the porcelain and other items from the above contexts would have suggested.

---

<sup>85</sup> Roberts, Sarah. "Sarah's Field Blog."

## JBH 62

Artifact Description	Production Range (years)
Canvas Tarp	Unknown
Plastic Part	1909-present, (Bellis)

JBH 62 is the most significant architectural find in Unit 8. Before this, there were no divisions in the unit, like those found in the lower yard units 6 and 7, where stone structures divided the space. It is unfortunate that the group did not uncover the gravel deposit until the last day of excavations, but it is also not imperative that future excavation seasons concentrate their efforts on this spot, due to the implications of this find.

## Conclusions

It seems apparent that the gravel deposit, due to the cloth tarp and plastic piece that are obviously manufactured, is a more recent intrusion than some of the artifacts of the contexts above it would suggest.

The general hypothesis then, is that after whatever exists below the gravel was filled in and capped, these layers of soil, artifacts and rocks were placed on top of it, perhaps from elsewhere on the property or from nearby. A detailed analysis of similarities in artifact remains and soil composition, perhaps, would be beneficial for predicting the location of the soil's original context.

This hypothesis would explain why there was relatively little change in soil composition, or diversity of artifact finds across the different contexts. Along with arbitrary context changes based on depth, we made context changes based on quantity and size of rocks within the soil. Essentially, contexts 43 through 57 can be interpreted as a relatively homogenous fill, not layered, as naturally deposited soil would be.

There have been assertions made that beneath the gravel deposit lays an old dry well that was filled in during the 1940s<sup>86</sup>, but documents and other accounts would be necessary to support this conclusion. It is also possible that the high levels of porcelain, creamware, and whiteware found in Unit 8 attest to the unit's close proximity to the kitchen area and outbuildings, but due to the contemporary nature of the manufactured cloth tarp and homogenous gravel fill found below these artifact deposits, it is more likely that the soil from contexts 43 through 57 was deposited there afterward, to bury the gravel fill. Perhaps wherever this soil was taken from is closer to where the kitchen and outbuildings were located, lower down in the yard, and the earthenware finds from STP3 this season could perhaps shed more light on that situation.

---

<sup>86</sup> Fishman, Bernard P. Personal Communication.

## Works Cited

Ament, Phil. Duct Tape. Troy MI: 1997-2007 The Great Idea Finder, 5 April 2006. Online. Available: <http://www.ideafinder.com>. 30 November 2009.

Archaeological Laboratory Artifact Codebook. University of Massachusetts Boston, Center for Cultural and Environmental History. 2004.

Bellis, Mary. The History of Plastics. <<http://inventors.about.com/od/pstartinventions/a/plastics.htm>>.

Fishman, Bernard P. Personal Communication.

Florida museum of natural history artifact identification guide  
Arch of college hill 2008

"Geothermal Power." Wikipedia Online Encyclopedia.  
<[http://en.wikipedia.org/wiki/Geothermal\\_power](http://en.wikipedia.org/wiki/Geothermal_power)>.

Mittman, Alexander. Object Biographies

Mrozowski, Stephen A. Living on the Boott: Historical Archaeology at the Boott Mills Boardinghouses, Lowell, Massachusetts. U of Mass Press: 1996.

Roberts, Sarah. Object Biographies.

Roberts, Sarah. "Sarah's Field Blog."

Sammartino, Laura. "Laura's Field Blog."

Seiden, Andrew. Object Biographies.

Stelle, Lenville J. 2001. Archaeological Guide to Historic Artifacts of the Upper Sangamon Basin. Center For Social Research, Parkland College.  
<<http://virtual.parkland.edu/lstelle1/len/archguide/documents/arcguide.htm>>.

## CHAPTER 8 Unit 9 and STP 3 Excavation Summary

Michael Camarillo

The John Brown House was the location of the 2009 fieldwork season for the Archaeology of College Hill class provided by the Joukowsky Institute of Archaeology and the Ancient World. Excavations were conducted every Monday afternoon beginning on September 14 and with the final closing of all units on November 9. A total of five units were opened this field season—initially consisting of Unit 6-9 and concluding with STP 3 replacing Unit 9 due to unforeseen underlying features, which will be discussed in more detail.<sup>87</sup> The excavations were led by Krysta Ryzewski with the assistance of Alex Knodell and Elise Nuding. As will be discussed in more detail, the work on Unit 9 and STP 3 was predicated by the coming plans to place geothermal wells in their locations in the summer of 2010. This fieldwork season presented the last opportunity to study the underlying context prior to the inevitable and total damage that would ensue with the summer alterations. The following summary will illuminate the methodology of excavation, possible interpretations of the artifacts and their associated contexts, and an examination of the artifacts in terms of dating, relationships, and means of manufacturing.

### Unit 9

#### Location

Unit 9 is placed approximately 4 meters west of the West wall of John Brown House facing Benefit Street. An important note is that the wall which the plot is adjacent to is part of the renovations added following the transfer of ownership from the family to Robert H. Ives in 1854 and Marsden Perry 20<sup>th</sup> century. Since its potential is greatly unsubstantiated by from other sources or past excavations, the unit was relatively small compared units, only measuring



Brown during the to the other

1x1 meters.<sup>88</sup> Its close proximity to the house suggests probable significance of discarded household

objects. Unit 9 is far removed from the other units, with the exception of Unit 8—which is also located next to the house just north of the 1x1 meter plot—as the Unit 6 and 7 are

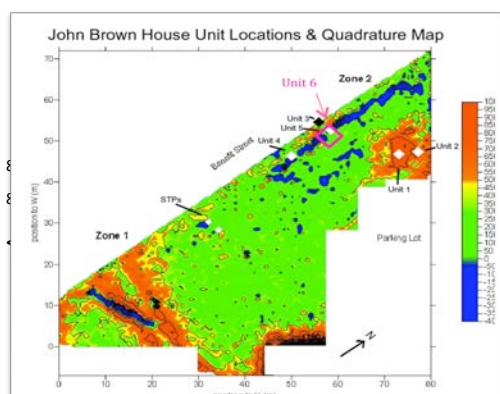

<http://proteus.brown.edu/archaeologyofcollegehill/9081>  
aries. September 9, 2009  
egehill/8919>

placed in the West perimeter of the yard near Benefit Street. Another factor distinguishing this unit from the others is that Unit 6 and 7 are based on features found during the preceding 2008 field season and the evidence of possible subsurface remains from the 2008 Geophysical survey.

### Methodology

The work began on Monday, September 9, 2009, with an initial introduction of the site, its history and significance, reasoning for determining unit placement, and an overview of delineating the units to begin excavation. The initial group for Unit 9 included Elise Merchant, Alex Mittman, and me; however, the other two were later dispersed to other units and I was joined by Julie Pridham. We commenced in placing stakes in the corners of the unit, to which we then attached and encompassed the plot with string. This outline would act as a guiding perimeter for the walls of our unit. Following this process, with the use of string, a line-level, and a tape measure, we attempted to locate the datum point—the point of highest elevation, which would allow even digging amidst uneven terrain—found to be the Northwest corner of the plot. Shovel-shaving of the overlying vegetation proceeded, followed by creating a wall by inserting the shovel approximately 2 centimeters into the surface and breaking the soil. This was the extent of our use of shovels, as it was necessary to slowly degrade the surface with trowels so to prevent damaging the underlying context and artifact associations.

### Stratigraphy

Unit 9 encompassed a total of three different levels—two of which were reached by the arbitrary centimeter limit and one as a result of a natural stratigraphic change in soil composition. The uppermost layer is JBH 44 (JBH denoting John Brown only including the vegetation at the surface and approximately 2 cm in depth across the plot. We



context  
10  
House),  
reached

a second context level before the end of the first day, as JBH 47 was initiated by the emergence of light brown soil speckling the darker soil of JBH 44, thus the presence of a natural context level.<sup>89</sup> This concept is called mottling, which is defined by the appearance of a different soil color and composition. JBH 47 extended the allotted 10 cm accomplishing the arbitrary limit for context changes, being followed by JBH 53 at approximately 12 ½ cm in depth—a context that nearly reached a natural stratigraphic change at 10 cm due to soil discoloration, unrealized since the change was not uniform throughout the plot.<sup>90</sup> The final context level, JBH 53 achieved an average depth of 22 ½ cm; however, the unit was closed due to the

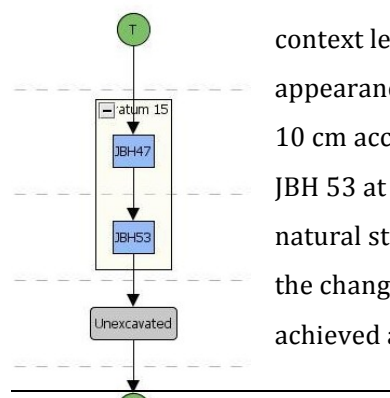

<sup>89</sup> Excavation Form. JBH 44

<sup>90</sup> Image by Sarah Baker. Excavation Form. JBH 47

emergence of a main electrical wire stretching across the plot from the Northwest to the Southwest corner.

**JBH 44**

JBH 44, the topsoil layer which reached a depth of 2.3 cm in the Northwest corner and center, 2.5 cm in the Southwest corner, 2.4 cm in the Northeast corner, and 2 cm in the Southeast corner, was excavated by a combined effort of shovel-shaving and troweling. The soil was a dark black with a Munsell reading of 7.5 YR 2.5/1—however, a recurring issue that may have hindered the accuracy of the Munsells was the excessive weekend rains which caused the uppermost soil to be relatively moist.<sup>91</sup> Most likely due to the small area that was included, this context level failed to produce many artifacts of any clear significance. Emerging in the center and eastern wall of the plot were close associations of slate rock—this is important due to the use of slate/shale for roof tiles. The fragments can be identified by their grey color and the breakage, as slate only has two lines of breakability: cleavage and grain.<sup>92</sup> In addition to the slate fragments, two pieces of brick of red clay and the other sandstone), wood, and three pieces of anthracite coal were uncovered. Although the slate, brick, and wood are all non-diagnostic, together, they are suggestive of architectural remains. This promoted the conjecture that the central association of rocks might be part of an underlying feature.



has  
(one

Artifact	Date
Anthracite Coal	1795-present ( <a href="http://www.pacoalhistory.com/history/tech&amp;indrev.html">http://www.pacoalhistory.com/history/tech&amp;indrev.html</a> )

The three anthracite coal pieces were the only diagnostic artifacts, therefore, acting as my TPQ object. Anthracite coal was discovered in Northeastern Pennsylvania at the turn-of-the-19<sup>th</sup>-century. First being used as a substance for heating in anthracite-fired iron furnaces in 1795 and experimentally burned in residential houses in 1808, it maintained its status as the most popular heating fuel in the northern United States from the 1800s through the 1950s.<sup>93</sup> Anthracite

<sup>91</sup> Pridham, J. Field Blog. September 28, 2009 <<http://proteus.brown.edu/archaeologyofcollegehill/9073>>

<sup>92</sup> Wikipedia: The Free Encyclopedia. *Slate*. 10 December 2009 10:26. December 11, 2009. <<http://en.wikipedia.org/wiki/Slate>>

<sup>93</sup> Black Diamonds: Experience Pennsylvania’s Anthracite Mining Heritage. *History*. Schuyl, Inc. December 13, 2009. <<http://www.pacoalhistory.com/history/tech&indrev.html>>



is still commonly used today, be it in generating steam electric power or landscaping purposes. This information allowed us to date the artifacts within the range, 1795-present.

**JBH 47**



JBH 47 began with an average entrance measure of 2 ½ cm in depth, distinguished from the other levels as it was a result of a natural stratigraphic change, determined by the mottling of the soil. The soil composition was much rockier than the preceding context and appeared yellow-brown in color, with a Munsell of 5 YR 3/2. This

context presented a much higher density of artifacts, both diagnostic and otherwise, than JBH 44.—the wide range of manufacturing dates suggest a constant turnover and backfill of the soil. As noted on the table to the right, the TPQ object of this context was a piece of plastic measuring about 2 cm wide.

This object is not present in the artifact picture above as it was misplaced in another context bag at the time of the picture. Since plastic was first introduced into the United States in 1855, this object could be dated 1855-present.<sup>94</sup> Most of the artifacts represented a date range beginning between the late-18<sup>th</sup> century and early-19<sup>th</sup> century—suggesting primary modification of this context by the Brown family, who owned the house between 1786 and 1854. Some of the earlier objects,

which included a



<sup>94</sup> Wikipedia: The Free Encyclopedia. *Plastic*. 15 December 2009. <<http://en.wikipedia.org/wiki/Plastic>>

Chinese Porcelain (Ching Blue on White)	1644-1912 (FLMNH)
Chert Stone Tool	-
Anthracite Coal	1795-present ( <a href="http://www.pacoalhistory.com/history/tech&amp;indrev.html">http://www.pacoalhistory.com/history/tech&amp;indrev.html</a> )
Creamware (plain)	1762-1820 (FLMNH)
Chinese Porcelain (Ching Polychrome Overglaze)	1700-1750 (FLMNH)
Chinese	1644-1912 (FLMNH)

sherd of creamware pottery and two pieces of Chinese porcelain—one decorated with a gold and red floral overglaze and the other with a blue on white design, both manufactured during the Ching Dynasty.<sup>95</sup> The close proximity to the house, most convincingly justifies the prevalence of hand-painted porcelain. Fittingly, John Brown, being of high social status, was involved with the international trade that defined Providence's colonial history. Anthracite coal was also found, similarly to JBH 44, and as will be seen as a recurring theme throughout the other contexts.

Another important artifact for dating purposes of JBH 47 was a handful of cut nails and, mostly, a screw measuring 47.8 mm long. These artifacts further suggest the possibility of an underlying architectural feature; although, the centralized association of rocks from JBH 44 proved to be nothing more than naturally forming materials. The screw is dated 1849-present. Noting that the first lathe for making screws in America dates to 1760, the gimlet point—threaded cone points usually having point angles of 45-50 degrees—can only achieve a date of the 1837 U.S. Patent 154 filed by Sloat and Springsteen.<sup>96</sup> However, the first use of this threading system did not occur until 1849. As we reached the arbitrary 10 cm context level, an upwelling of red-brown dirt was observed in the Southwest corner. This was not uniform throughout the plot; therefore, the decision was made to go by arbitrary measurements. The final occurrence in JBH 47 was the emergence of a bent, black and red pipe stretching across the Southeast corner, as noted by the arrow in the picture above. It was later



determined that this was a model of modern infrastructure, part of the surrounding sprinkler system.<sup>97</sup>

### **JBH 53- Close of Unit**

A mottled red-brown soil with intermittent dark brown-black spots and a Munsell value of 10 YR 3/2 characterized the initial layer of JBH 53, the final context of Unit 9.<sup>98</sup> Prior to beginning this context, approximately 4 inches of water needed to be bailed

out

<sup>95</sup> Historical Archaeology: At the Florida Museum of Natural History. *All Types in Collection: Ceramics*. Florida Museum of Natural History. 1995. December 13, 2009 <[http://www.flmnh.ufl.edu/histarch/gallery\\_types/type\\_list.asp](http://www.flmnh.ufl.edu/histarch/gallery_types/type_list.asp)>

<sup>96</sup> White, Christopher. *Observations on the Development of Wood Screws in North America*. Museum of Fine Arts: Boston. 2005

<sup>97</sup> Excavation Form. JBH 47

<sup>98</sup> Excavation Form. JBH 53



Artifact	Date
Landscaping tag (Watercreeper Purple Leaf) (TPQ)	1993-present (copyright)
PVC Pipe	1926-present (1993?) ( <a href="http://en.wikipedia.org/wiki/Plastic">http://en.wikipedia.org/wiki/Plastic</a> )
Plastic	1855-present ( <a href="http://en.wikipedia.org/wiki/Plastic">http://en.wikipedia.org/wiki/Plastic</a> )
Screw	1837-present
Porcelain, England (Bone China)	1830-1900 (FLMNH)
Cut Nails	1820-1910 (FLMNH)
Anthracite Coal	1795-present ( <a href="http://www.pacoalhistory.com/history/tech&amp;indrev.html">http://www.pacoalhistory.com/history/tech&amp;indrev.html</a> )
Cut Stake	-

of the unit since the weekend's rain had infiltrated our plot. This could have altered the accuracy of the Munsell reading. The exit measures of JBH 47 were 12.3 cm across the West wall and the center of the plot, with the Northeast corner at 12.5 cm and the Southeast corner at 13 cm in depth.<sup>99</sup> We continued a slow process of degrading the subsurface with trowels and dustpans, attempting to avoid damaging the pipe in the Southeast corner. It became apparent that backfill had occurred, at least in the Southeast corner, as a cut piece of black and red pipe, fragmented concrete, and a landscaping tag were in close association with the sprinkler pipe. The landscaping tag was the TPQ object of the context as it had a copyright date in the text of 1993, thus dating the artifact 1993-present. Most of the artifacts were similar to those already found in JBH 44 and JBH 47—plastic, a screw, cut nails, a porcelain sherd, and anthracite



coal. The PVC pipe fragment left room for conjecture. Plasticized pipe was first introduced and used in residential areas in America in 1926 due to its flexibility and utility in the presence of other underlying features.<sup>100</sup> However, considering the fact that the sprinkler system was most likely added at the same time as the Watercreeper Purple Leaf (as noted on the landscaping tag), intuitively, the pipe might be dated from 1993 instead of 1926-present.

On October 26, we encountered an unforeseen obstacle stretching across the plot from the Northwest corner to the Southeast corner. A grey electrical wire emerged through our troweling at approximately 22 ½ cm in depth. Due to the hazards of digging around the wire, as well as the possible damage that could be caused to modern utility, Unit 9

was



<sup>99</sup> Excavation Form. JBH 53

<sup>100</sup> Wikipedia: The Free Encyclopedia. *Polyvinyl chloride*. 11 Dec 2006. <[http://en.wikipedia.org/wiki/Polyvinyl\\_chloride](http://en.wikipedia.org/wiki/Polyvinyl_chloride)>

forcibly closed.<sup>101</sup> The wire mostly likely connects the electrical box (on the West wall about 4 meters from the plot) to the ground lights along the pathways. The state preservation plans suggest that the wire should be located 3 feet to the North of its location.

---

### **STP 3**

#### **Location**

Following the closing of Unit 9, Krysta decided that we should work on a shovel test pit (STP), since the limited allotted time remaining did not allow for opening another unit. The STP would be excavated in natural stratigraphic levels, as opposed to arbitrary levels in Unit 9. After joint deliberation, the plot was placed just east of the walkway that connects the the parking lot—slightly closer to Benefit Street but close proximity to the house relative to Unit 6 and 7. to Unit 8 and 9, STP 3 presented the opportunity to the upcoming damage by the geothermal wells, thus continuing our endeavor of mitigation archaeology and enhancing the necessity for responsible record keeping. The close proximity to the addition that housed the kitchen proves critical to the interpretation of the found artifacts.



to the plot was house to still in Similarly alleviate

#### **Methodology**

This unit was approached differently than Unit 9, as the excavations commenced with the use of primarily shovels and a limited use of trowels. The plot was first delineated with 4 tape measures; we placed stakes in each of the corners and, with the use of a line-level, we found the datum point to be the Northeast corner. Beginning much smaller than the other units (75cm x 75cm), the wall was outlined with the use of a shovel.<sup>102</sup> Following this task, the upper sod level was removed and more initial photos were taken.

#### **Stratigraphy**



---

<sup>101</sup> Abed, S. & Camarillo, M. Excavation Summaries. October 26, 2009. <<http://proteus.brown.edu/archaeologyofcollegehill/8919>>

<sup>102</sup> Excavation Form. STP 3

STP 3 achieved two different natural context levels, distinguished by various soil composition and color alterations. Directly below the sod was JBH 55 which consisted primarily of roots and thick, dark black soil. This context extended down unevenly, nearly parallel with the overlying terrain, achieving a depth of approximately 12 cm on the West wall and 28 cm on the East wall. The advent of JBH 60 was linked emergence of a much rockier soil composition of a lighter color. Composed of a high degree of artifacts, both diagnostic and otherwise, JBH 60 did not follow the same the unevenness of the upper levels. Instead, the change greatly exaggerated with the West wall reaching a depth of 70 cm and the East wall only hitting 48 cm. The STP was upon reaching the sterile soil level, denoted by very light, brown soil.



wall and with the brown degree of was about 70 complete sandy

### JBH 55

The soil directly below the sod level was much thicker, organic even, than that of Unit 9, with a Munsell of 10 YR 3/2.<sup>103</sup> Once again, the wet soil from the weekend rain may have affected the Munsell values. An increased abundance of roots slowed the first day of work, requiring the use of tree trimmers and shovels. Consisting widely of fragmented pieces of non-diagnostic glass and a piece of fabric, the majority of the artifacts were not found until we reached a depth near the following context level. Anthracite coal was again present but in much larger amounts, suggesting a possible area for discarded household materials. Large pieces of slate

Artifact	Date
Whiteware (TPQ)	1830-present (FLMNH)
Porcelain (green on white)	1829-1839
Anthracite Coal	1795-present ( <a href="http://www.pacoalhistory.com/history/tech&amp;indrev.html">http://www.pacoalhistory.com/history/tech&amp;indrev.html</a> )
Creamware (plain)	1762-1820 (FLMNH)



Chinese Porcelain	1644-1912 (FLMNH)
-------------------	-------------------

<sup>103</sup> Abed, S. & Camarillo, M. Excavation Summaries. October 26, 2009. <<http://proteus.brown.edu/archaeologyofcollegehill/8919>>

(plain)

\_\_\_\_\_ were also present. As aforementioned, this could indicate the presence of underlying features in the near vicinity. The TPQ object was a sherd of whiteware pottery dating 1830-present. Whiteware is the common material used in manufacturing kitchenware vessels such as bowls, cups, plates, platters, and tea pots.<sup>104</sup> Therefore, the close proximity to the house may be worth noting.

## JBH 60

JBH 60 was the final context level of STP 3; the soil included a greater number of inclusions and was a lighter brown color with a Munsell value of 10 YR 4/3.<sup>105</sup> The prevalence of roots subsided with the substitution of large rocks and brick fragments. This context produced a substantial amount of artifacts that dwarfed that of any other context level in both Unit 9 and The largest conglomeration of glass was present in JBH numerous fragments of non-diagnostic colored, opaque, translucent glass further indicated the practice of backfill modern interference with the stratigraphic level.

Regardless of the wide date range of the artifacts (1640-present), they all share a relative period at some point of manufacturing range, that being during the Brown ownership of the house. Amidst the jumble of non-

diagnostic artifacts, a significant accumulation of pottery sherds was present which included: whiteware, earthenware, pearlware, creamware, salt-glazed stoneware, porcelain, and delftware. The whiteware was, again, the TPQ object (1830-present) promoting the conjecture of a broken kitchenware pit. A number of these wares were popular during the time when John Brown owned the house— notably, the refined earthenware (annular ware) reached its highest popularity during the period 1795-1815 and delftwares, which were mass produced in 1640, celebrated much of their output to America in the third quarter of the 18<sup>th</sup> century, as late as 1791.<sup>106</sup>



STP 3.  
60—  
and  
and  
their

<sup>104</sup> Historical Archaeology at the Florida Museum of Natural History. *Creamware, Plain*. Florida Museum of Natural History. 1995. December 14, 2009

<[http://www.flmnh.ufl.edu/histarch/gallery\\_types/type\\_index\\_display.asp?type\\_name=CREAMWARE,%20PLAIN](http://www.flmnh.ufl.edu/histarch/gallery_types/type_index_display.asp?type_name=CREAMWARE,%20PLAIN)>

<sup>105</sup> Excavation Form. STP 3

<sup>106</sup> Hume, Ivor N. *A Guide to Artifacts of Colonial America*. UPenn Press: Philadelphia. 1969. pg. 107-108, 131

<b>Artifact</b>	<b>Date</b>
<b>Whiteware (TPQ)</b>	<b>1830-present (FLMNH)</b>
Cut Nails	1820-1910 (FLMNH)
Anthracite	1795-present
Coal	( <a href="http://www.pacoalhistory.com/history/tech&amp;indrev.html">http://www.pacoalhistory.com/history/tech&amp;indrev.html</a> )
Refined Earthenware (annular)	1785-1840 ( <i>A Guide to Artifacts of Colonial America</i> )
Refined Earthenware (blue transfer print)	1783-1830 ( <i>A Guide to Artifacts of Colonial America</i> )
Pearlware (plain)	1775-1830 (FLMNH)
Creamware (plain)	1762-1820 (FLMNH)
White Salt-glazed Stoneware	1720-1770 (FLMNH)
Poured Stoneware (molded)	1720-1770 (?)
Porcelain (plain)	1660-1800 (FLMNH)
Chinese Porcelain (Ching blue on white)	1644-1912 (FLMNH)
Delftware	1640-1800 ( <i>A Guide to Artifacts</i> )



The floor of STP 3 was greatly uneven, following the overlying terrain with its westward slope, but to an exaggerated extent. Our final efforts in the unit were with trowels and dust pans; however, the process became rather difficult as the pit reached approximately 70 cm on the West side and 48 cm on the East side. As the last day came to an end, we reached sterile soil (a Munsell value of 10 YR 6/6) which indicated the completion of STP 3.<sup>107</sup>

### Conclusions

For Julie and me, the 2009 fieldwork season has been a matter of accomplishing rescue archaeology for the area in which geothermal wells may be installed during the summer of 2010. Our work did not produce substantial evidence of underlying features when compared to the ‘walls’ (or architectural features) of Unit 6 and 7. However, the significant amounts of diagnostic pottery in both Unit 9 and STP 3, in sure consideration with the proximity to the John Brown House, have increased the importance of future work in their vicinity. The artifacts were often found in too close association to one another to be a factor of random displacement. In addition, the non-diagnostic fragments of brick, slate, and human-cut wood abet the claim of possible outbuildings being buried near the main house. Unit 9 provided valuable information that must be made note of, since the upcoming work in the summer could have endangered those working on the project based on the state preservation plans. The impetus for further excavation is highest around STP 3

<sup>107</sup> Excavation Form. STP 3

with the large accretion of earthenwares and anthracite coal. Based on the research and excavations undergone in the 2009 field season, the best recommendation would be to postpone the geothermal well projects and implementing a high priority excavation of the area surrounding the walkway. Otherwise, valuable information about the history of the John Brown House could be forever damaged.

### **Works Cited**

Abed, S. & Camarillo, M. Excavation Summaries. October 26, 2009. <  
<http://proteus.brown.edu/archaeologyofcollegehill/8919>>

Black Diamonds: Experience Pennsylvania's Anthracite Mining Heritage. *History*. Schuyl, Inc. December 13, 2009. <<http://www.pacoalhistory.com/history/tech&indrev.html>>

Camarillo, M. Field Blog. September 9, 2009  
<<http://proteus.brown.edu/archaeologyofcollegehill/9081>>

Excavation Form. JBH 44

Excavation Form. JBH 47

Excavation Form. JBH 53

Excavation Form. STP 3

Historical Archaeology: At the Florida Museum of Natural History. *All Types in Collection: Ceramics*. Florida Museum of Natural History. 1995. December 13, 2009  
<[http://www.flmnh.ufl.edu/histarch/gallery\\_types/type\\_list.asp](http://www.flmnh.ufl.edu/histarch/gallery_types/type_list.asp)>

Historical Archaeology at the Florida Museum of Natural History. *Creamware, Plain*. Florida Museum of Natural History. 1995. December 14, 2009  
<[http://www.flmnh.ufl.edu/histarch/gallery\\_types/type\\_index\\_display.asp?type\\_name=CREAMWARE,%20PLAIN](http://www.flmnh.ufl.edu/histarch/gallery_types/type_index_display.asp?type_name=CREAMWARE,%20PLAIN)>

Hume, Ivor N. *A Guide to Artifacts of Colonial America*. UPenn Press: Philadelphia. 1969. pg. 107-108, 131



Merchant, E. & Pridham, J. Excavation Summaries. September 9, 2009  
<<http://proteus.brown.edu/archaeologyofcollegehill/8919>>

Pridham, J. Field Blog. September 28, 2009 <<http://proteus.brown.edu/archaeologyofcollegehill/9073>>

White, Christopher. *Observations on the Development of Wood Screws in North America*. Museum of Fine Arts: Boston. 2005

Wikipedia: The Free Encyclopedia. *Plastic*. 15 December 2009. December 15, 2009.  
<<http://en.wikipedia.org/wiki/Plastic>>

Wikipedia: The Free Encyclopedia. *Polyvinyl chloride*. 11 December 2009. December 13, 2009  
<[http://en.wikipedia.org/wiki/Polyvinyl\\_chloride](http://en.wikipedia.org/wiki/Polyvinyl_chloride)>

Wikipedia: The Free Encyclopedia. *Slate*. 10 December 2009 10:26. December 11, 2009.  
<<http://en.wikipedia.org/wiki/Slate>>

## **CHAPTER 9 Landscape Archaeology of the John Brown House Property**

Julie Pridham

After two seasons of excavation and research at the John Brown House, numerous discoveries have provided insight into the landscape composition of the property. To supplement this information and to build off of documentary research conducted during the 2008 season, this report aims to provide an extensive list of all structures once present on the John Brown House property. Using primary research conducted at the John Brown House, the Rhode Island Historical Society Library, and Providence City Hall, the following report merges textual and cartographic evidence of past structures. First is an examination of the landscape change at the John Brown House, which regards both the John Brown House and its outbuildings, and the Robert Hale Ives house and its outbuildings. This analysis will extend from the construction of the John Brown House under John Brown through the changes conducted by the Rhode Island Historical Society. After tracking the changes to the landscape using primary historical documents, I will reexamine finds from the 2008 and 2009 excavation seasons, including the geophysical survey conducted in 2008, to contextualize certain finds. The final section of the report includes the comprehensive lists of structures.

### **I. Landscape History Before 1857**

Before the 1857 *Map of the City of Providence* by Henry F. Walling, no cartographic evidence of the John Brown House shows the buildings on the property. However, other primary resources, such as deeds, wills, and personal letters, which predate the 1857 Walling Map, provide a brief description of the John Brown House and its outbuildings. John Brown began construction on his house beginning in 1786. The family moved into the property in 1788 in preparation for his daughter's wedding. At this point, construction on the house was not yet completed. By the tax list dated to 1798, the house (50 x 54 feet) is listed along with two outbuildings, namely the "barn wood house" and chaise house.

In a later tax list dated to 1801, the outbuildings noted are a coach house, stables, and bathing house. Each of these outbuildings was constructed of wood, while the "wood house" was constructed of another material, most likely brick. After John Brown's passing in 1803, the schedule of the estate in his will describes the same outbuildings as the 1801 and 1798 tax lists. These outbuildings remained the same through Sarah



Brown's ownership of the land, as evidenced by the 1814 tax list.<sup>108</sup> The outbuildings were most likely located to the north and west of the John Brown House (JBH) proper. At some point in the mid 1800s, the wood outbuildings burned down.<sup>109</sup>

## II. Landscape History Based on Cartographic Evidence

The first map showing the structures on the JBH property is the 1857 *Map of the City of Providence* by Henry F. Walling (**Figure 1**).<sup>110</sup> The map shows the JBH along with one large outbuilding to the house's north. The map also shows a previously unmentioned structure, which for the purposes of this report will be called the Hale Ives House (HIH). Robert Hale Ives first acquired the property west of the JBH extending toward Benefit Street in 1831 when James Brown sold him the land (see Thelemaque, Alyssa Final Report). By 1832 Robert Hale Ives owned the western side of the property extending from Charlesfield to Power Streets along Benefit.<sup>111</sup>



<sup>108</sup> The information from the stated tax lists and will was collected by the Rhode Island Historical Society and can

**Fig. 1.** *Map of the City of Providence, 1857. Henry F. Walling*

This map shows that both buildings are present on the property, including their respective outbuildings.

revised February 1991. John Brown House Binder #4 JBH General Information and Descriptions: Room by Room, John Brown House Museum.

<sup>110</sup> Henry E. Walling. 1857. *Map of the City Providence*. Providence City Hall, Providence, RI. Also in the Rhode Island Historical Society Library (RIHS Library).

<sup>111</sup> "To illustrate different ownership of the land as bounded by Benefit, Power, and Charles Field Streets. (2)," John Brown House Binder #4 JBH General Information & Descriptions: Room by Room, John Brown House Museum.

Between 1832 and 1857 the HIH was built on the corner of Benefit and Charlesfield Streets. The 1857 *Walling map* shows a large structure extending along Charlesfield Street, though the house itself was listed as 327 Benefit Street.<sup>112</sup> Though it is difficult to distinguish in the reproduction, the Walling map shows a small outbuilding of the HIH located along the fence with the Charlesfield and Brown Street neighbor. It also illustrates that the house, located closest to the corner of Charlesfield and Benefit Streets was connected to another large structure, which later maps show as three connected outbuildings.

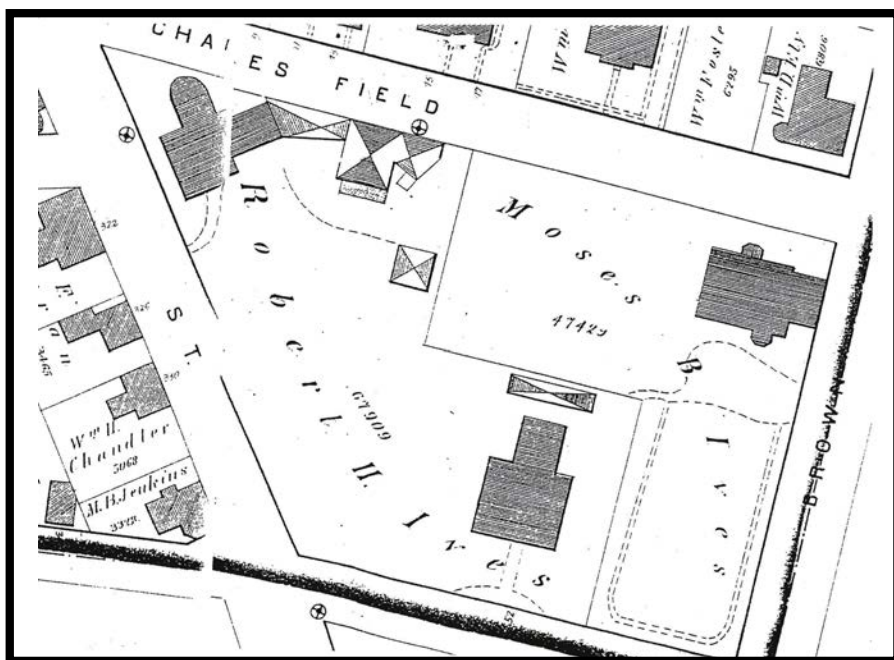

**Fig. 2** City Atlas of Providence Rhode Island and Parts of East Providence, 1875.

The next map showing the property is the 1875 *City Atlas of Providence Rhode Island and Parts of East Providence* (Figure 2).<sup>113</sup> This map illustrates the JBH and HIH with greater distinction of outbuildings. At the JBH, the “ell” addition has been added to the north side of the house. The long rectangular outbuilding is still to the north of the JBH. It is designated as an outbuilding by the larger X written through the structure. Both the JBH proper and the outhouse are constructed of brick as designated by the parallel lines filling both drawings. The 1875 *Atlas* also demarcates the three connected outbuildings of the HIH. The HIH proper and its connected outbuildings are constructed of brick. In addendum to the three large connected outbuildings

<sup>112</sup> Steffi Yellin. “Chapter 1: Historical Background of the John Brown House Property,” in *Archaeology of College Hill John Brown House, Providence, Rhode Island Archaeological Report*, Fall 2008. pg. 30.

<sup>113</sup> George W. Bromley. 1875. *City Atlas of Providence Rhode Island and Parts of East Providence*. Rhode Island Historical Society Library Cartography Collection.

appear to be two smaller connected outbuildings made of wood on the southern side. The smaller outbuilding to the east of the HIH is also shown more clearly. The dashed line present on the map which seems to frame the four outbuildings appears to be an indication of a driveway. This seems consistent with the similarly dashed lines leading from the JBH front to Power Street, and from the HIH to Benefit Street. The possible designation of driveways and pathways will be discussed in greater detail later on in this report.

**Fig. 3.** *Atlas of the City of Providence and Environs, 1882.*



The next map showing the structures is the *1882 Atlas of the City of Providence and Environs* (**Figure 3**). No changes to the structures have occurred, however, ownership of both plots including both houses is listed under Mrs. Elizabeth Amory Ives Gammell. Mrs. Gammell acquired the properties in 1875 upon the death of Robert Hale Ives.<sup>114</sup> Also dating to 1882 is a perspective view of Providence and the Power-Benefit-Charlesfield block (**Figure 4**). Though the origin and accuracy of this perspective drawing are unknown, it does serve to display the differing heights of the HIH outbuildings. It might also indicate that in fact no outbuildings were located in the western garden of the JBH property, also known as the orchards.<sup>115</sup>

<sup>114</sup> "To illustrate different ownership of the land as bounded by Benefit, Power, and Charles Field Streets. (2)," The John Brown House Binder #4, John Brown House Museum.

<sup>115</sup> "View of Providence," 1882. John Brown House Binder #2 JBH Related Materials. RIHS Library Archives.



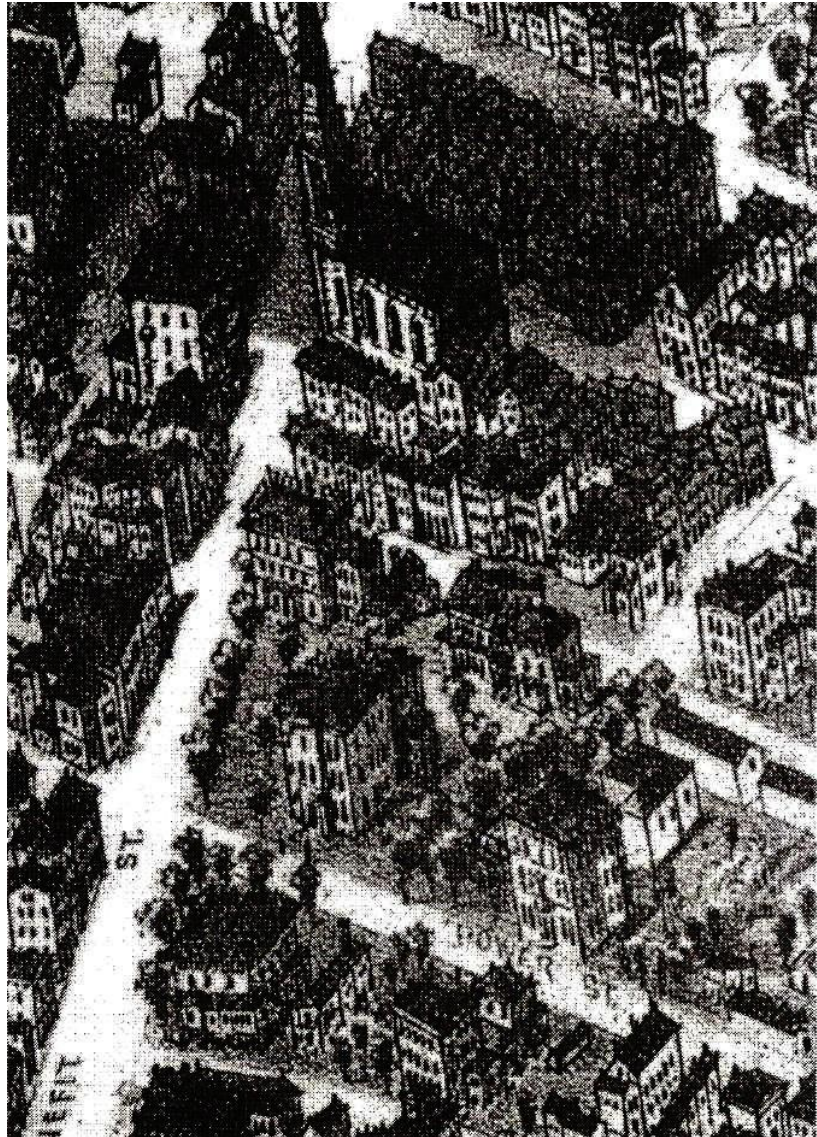

**Fig. 4.** *“View of Providence”, 1882.* [unattributed].  
This view shows the block containing the John Brown and Hale Ives houses, just in front of the Unitarian Church pictured at the top of the image.

For historical research, the Sanborn Fire Insurance Maps are a pivotal resource for identifying past structures and their building materials. This is likewise true of research for the JBH and HIH. The 1889 *Sanborn Fire Insurance Map* (**Figure 5**) does not reveal any changes to the footprint of the brick houses or the major outbuildings. However, the HIH exhibits two wooden porches on the southern side of the house. As well, we can now tell the HIH's disconnected outbuilding served as a carriage house. Based on this Sanborn map, we know that the HIH carriage house was constructed of wood.

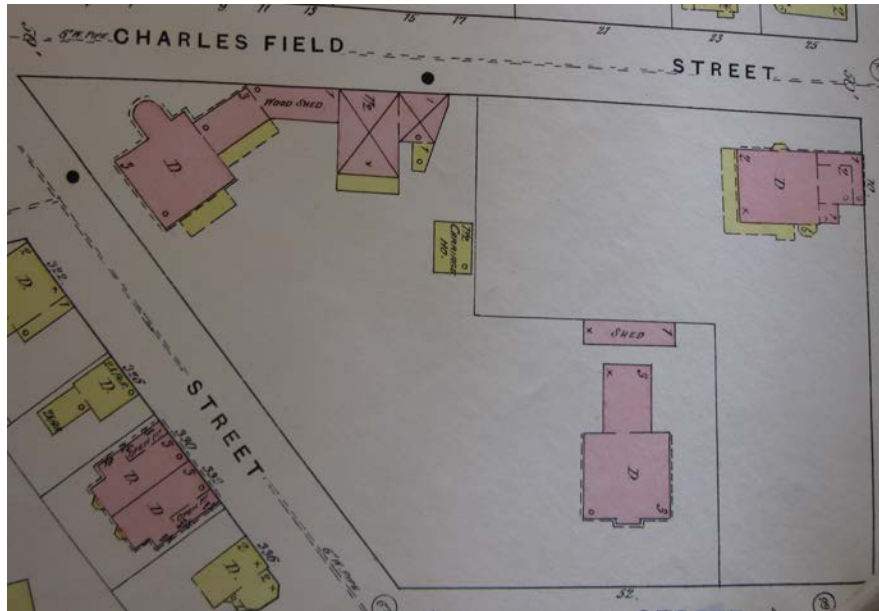

**Fig. 5.** *Sanborn Fire Insurance Map, 1889.* Brick is indicated by pink, wood by yellow.

Major changes to the property and its outbuildings occurred between the 1889 Sanborn map and the 1900 Sanborn map (**Figure 6**). By 1900 the HIH footprint changed significantly. While the original house is still intact, the three connected outbuildings have been torn down. In their place is a large residential addition to the house, with rounded extensions along Charlesfield Street and one reaching south-east from the house proper. To supplement the destruction of the three connected outbuildings and the carriage house, a very large outbuilding has been erected to the east of the house. Architecturally, this outbuilding appears to mimic the rounded features of the house. To separate the house from the outbuilding, a brick wall was constructed, as labeled in the 1900 Sanborn map. These changes presumably occurred under Robert Ives

Gammell, who officially owned the property beginning in 1878, when William and Elizabeth Gammell deeded him the land.<sup>116</sup>

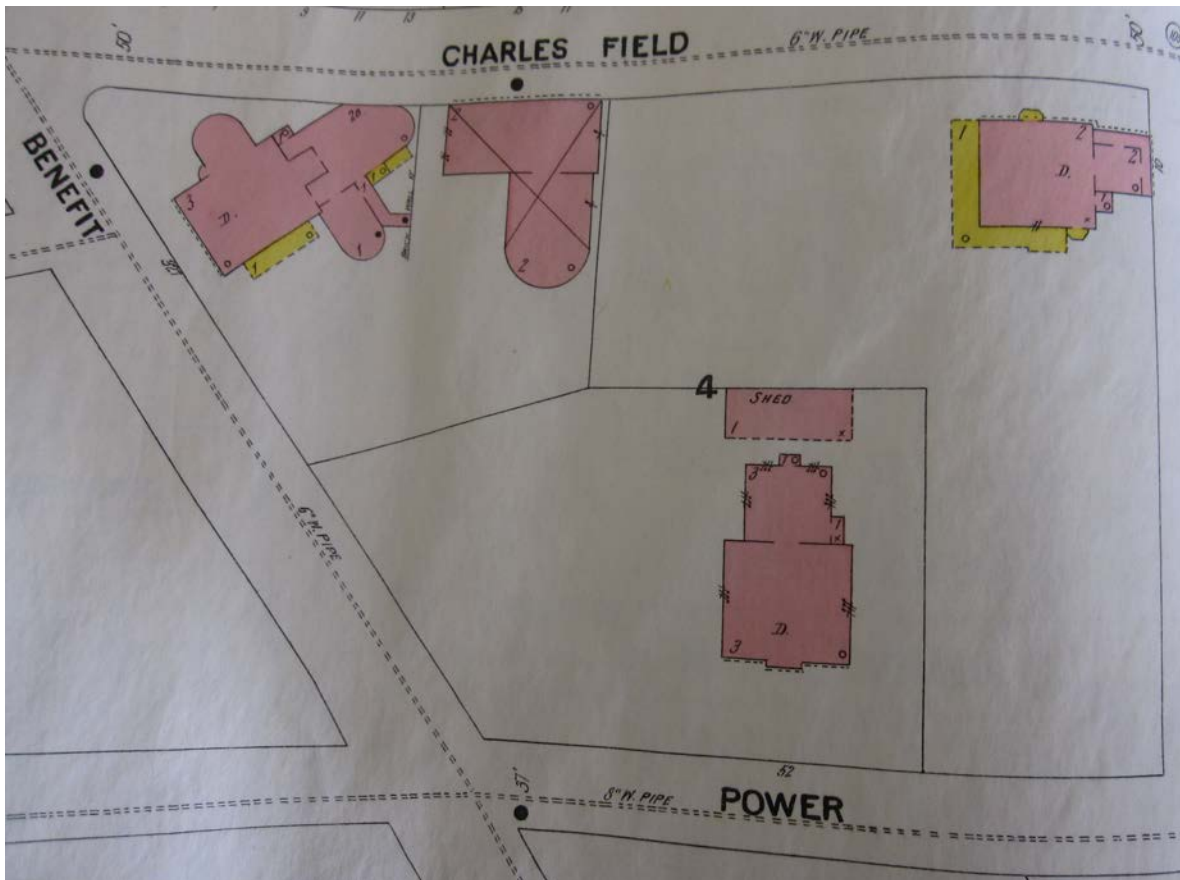

**Fig. 6.** *Sanborn Fire Insurance Map, 1900.*  
This map shows a number of changes to landscape, most notable the renovations done to the Hale Ives House.

<sup>116</sup> Deed, September 27, 1878. William and Elizabeth Gammell to Robert Ives Gammell. Recorder of Deeds and Land Evidences Office and City Hall Archives Office. Providence City Hall, Providence, Rhode Island.

In the 1900 Sanborn map we can for the first time see a line separating the HIH property and the JBH property. While this could have been the cartographer's preference to separate private plots, later evidence indicates that a fence did in fact separate the two. Evidence of the fence follows later in this report. The 1900 Sanborn map also shows minimal changes to the JBH. A small addition has been made on the north of the house, connecting to the "ell." Similarly, a small addition has been made to the east of the ell, connecting also to the original house. These changes probably occurred under the ownership of Elizabeth Ives Gammell or Harriett Gammell and Helen Gammell Herbet who owned the house following the death of their mother, Elizabeth Amory Ives Gammell in 1897 (see Thelemaque, Alyssa Final Report).

Eight years later, the *1908 Providence Platbook Map* (**Figure 7**) shows no changes to the houses or their outbuildings. The Gammells were still owners of the HIH property. Marsden J. Perry both the JBH property in 1901. While no changes have occurred to either house or their outbuildings, the platbook map does indicate pathways around both the HIH and JBH. In the 2008 report, Steffi Yellin hypothesized that the dashed lines around the HIH indicated the installation of sewer lines.<sup>117</sup> While sewer lines are denoted with dashed lines in the platbook maps, the coloration of the areas bordered by the lines, as well as their placement with regard to the house entrances and carriage houses, seems to indicate that these lines delineate walkways and driveways. For example, the lines around the JBH are in the placement of the walkways still extant today at the property, which were installed and lined with marble by Marsden J. Perry. The *1918 Providence Platbook Map* (**Figure 8**) seems to support the driveway theory, as we can see an indication of a drive extending to the HIH outbuilding as well as to the JBH carriage house.

---

<sup>117</sup> Yellin, p. 20.



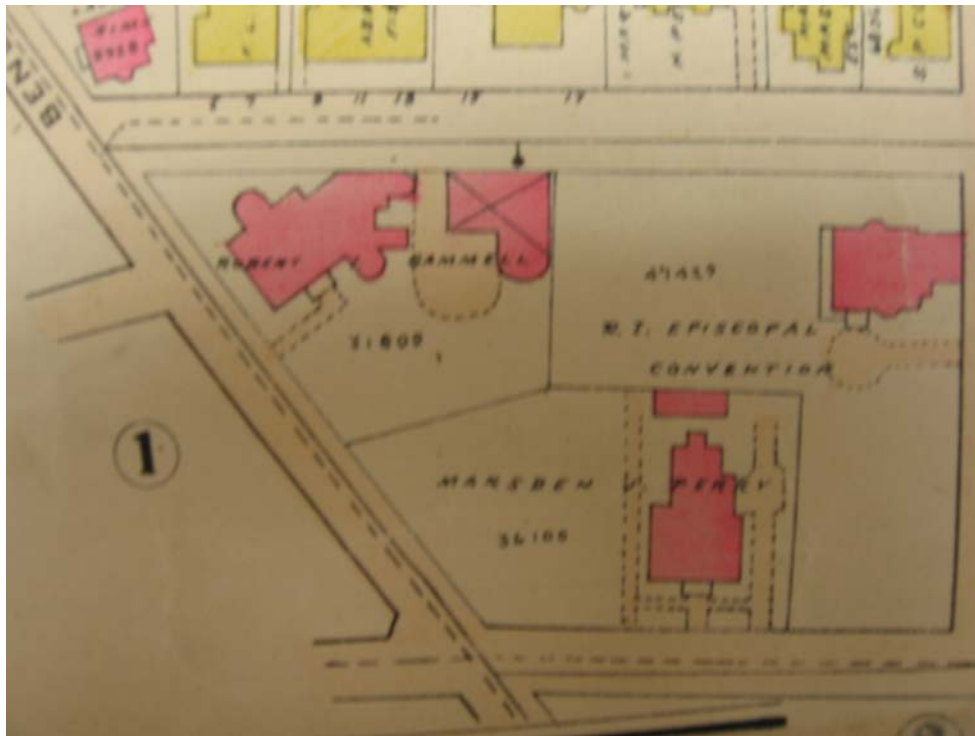

**Fig. 7.** Providence Platbook Map, 1908.

This map illustrates possible pathways and driveways connected to both of the houses.

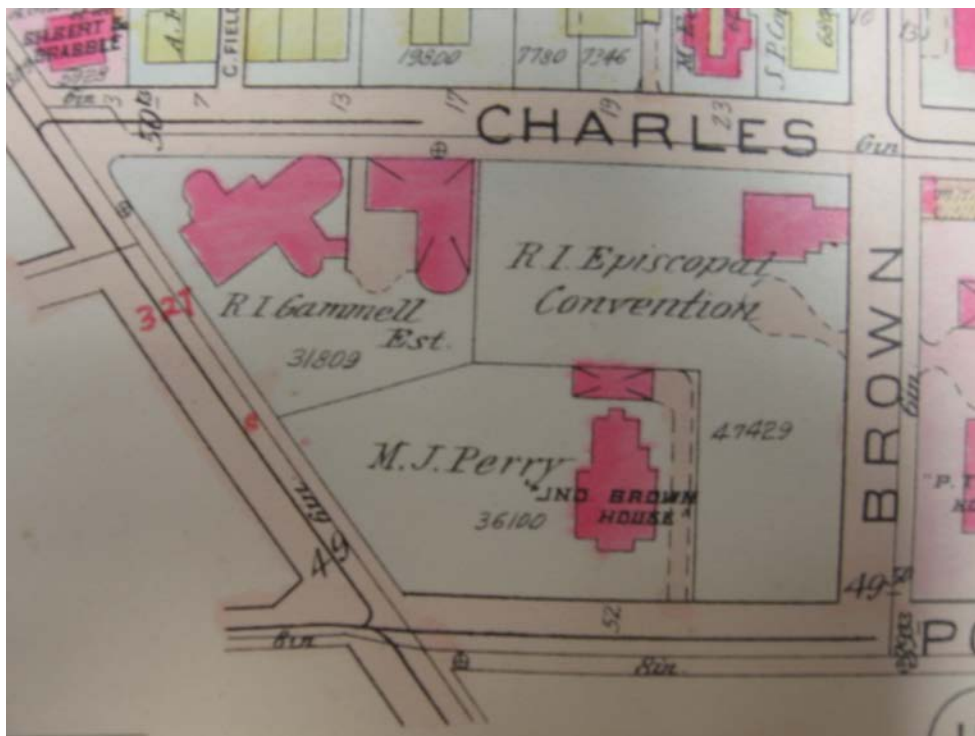

**Fig. 8.** Providence Platbook Map, 1918.

This map continues to show possible driveways connecting to the houses.



In 1921 the structures had not changed as evidenced by the *1921 Sanborn Fire Insurance Map* (**Figure 9**). However, in 1923 Marsden J. Perry bought the HIH property from Eliza Anthony Hoppin Gammell for \$100.<sup>118</sup> The *1926 Providence Platbook Map* (**Figure 10**) shows that by 1926 Perry had torn down the HIH. However, the line, presumably the fence, still separates the two plots. After his death in 1935, Perry's widow retained ownership of the property until 1936, when she sold the property to John Nicholas Brown. John Nicholas Brown then gave the property to the Rhode Island Historical Society for preservation in 1942 (see Thelemaque, Alyssa Final Report).

**Fig. 9.** *Sanborn Fire Insurance Map, 1921.*  
No noticeable changes to either property.

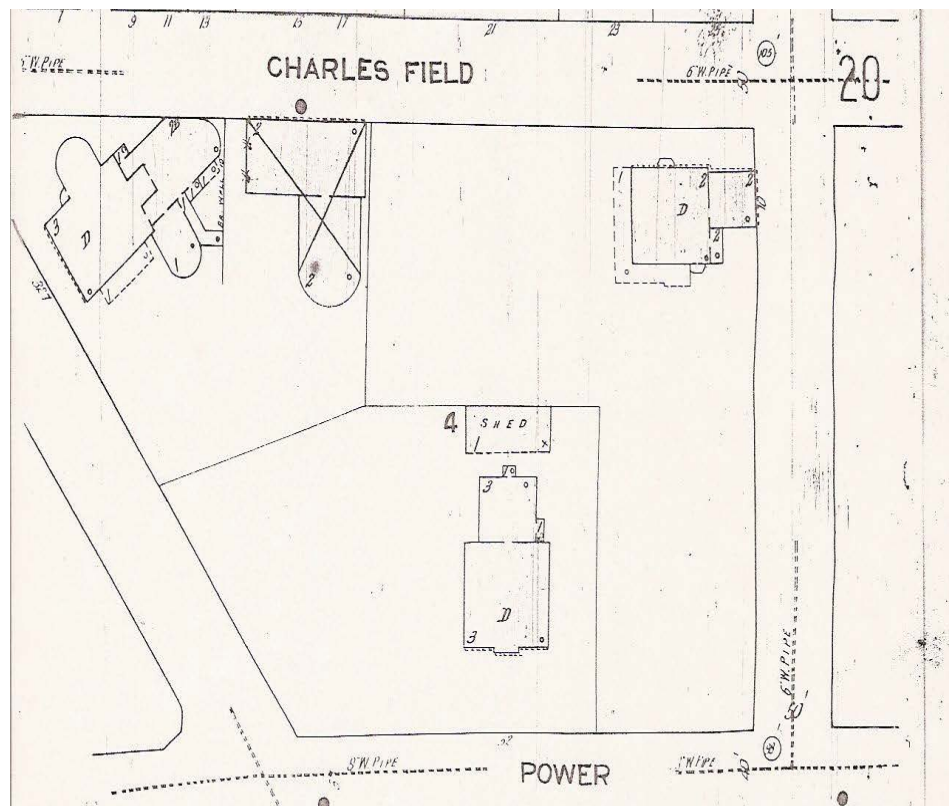

<sup>118</sup> Deed July 6, 1923. Eliza Anthony Hoppin Gammell to Marsden J. Perry. Recorder of Deeds and Land Evidences Office and City Hall Archives Office. Providence City Hall, Providence, Rhode Island.

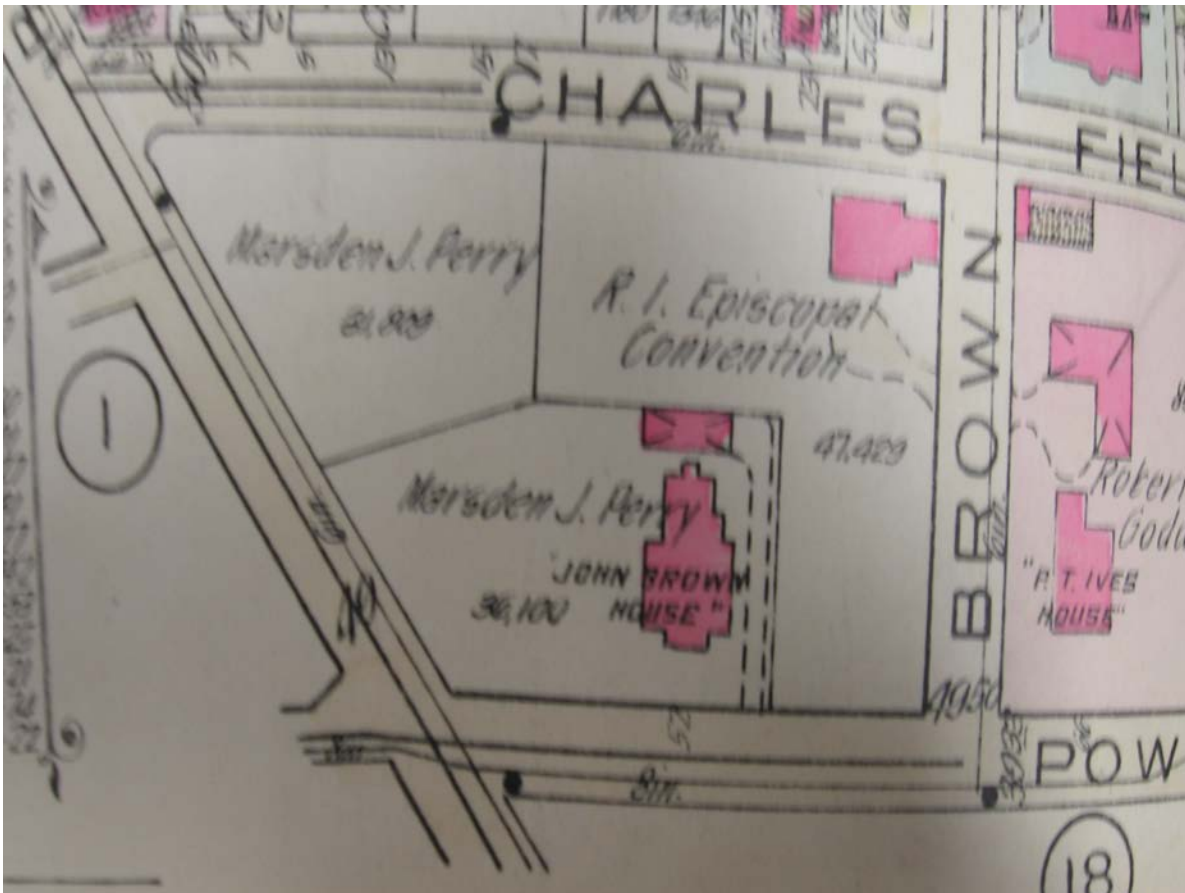

**Fig. 10.** *Providence Platbook Map, 1926.*  
Marsden J. Perry has acquired the Hale Ives property and has demolished the Hale Ives House.

Shortly after acquiring the property, RIHS began work on a possible parking lot to accommodate visitors to the pending JBH Museum and to accommodate members of the RIHS who worked in the building. The decision process was lengthy, however, the availability of different landscape plans provide information about the property's appearance shortly after Marsden J. Perry. They also help to determine the areas of the property and specifically of the demolished HIH that are currently beneath the parking lot. The first of the landscape plans showing a possible parking scheme dates to December 1950. This plan does not show any significant features throughout the JBH yard, except for a fountain in the garden west of the JBH.<sup>119</sup> Presumably this fountain was installed under Marsden J. Perry and removed at the time of the landscape renovation under the RIHS.

<sup>119</sup> Waterman Engineering Co. *Map of Land in Providence Rhode Island Belong to the Rhode Island Historical Society*. December 1950. [John Brown House Architectural Plans and Manuscripts Collection], RIHS Library.

The next plan, dated to May 30, 1959 also lacks evidence of permanent features in the yard, except for the fountain. The proposed parking lot featured in this plan was also one of the rejected designs. In May 1964, James D. Graham performed a grading study of the property to assess the possible parking situation. This plan most nearly matches the layout of the JBH's present parking lot, with the entrance at the mid-point of the Charlesfield fence, extending north toward the property line. This parking lot is adjoined by a new paved path leading up to the staircase on the terrace west of the JBH. Though this plan does not show the fountain in the western garden, it does denote a drain in the southwest corner of the proposed parking lot.<sup>120</sup>

The last landscape plan within the collections of the RIHS Library Archives was also from James D. Graham. No date was given for the plan, although the box itself ranged from ca. 1959-1988. Though it is possible that the plan was drawn as late as 1988, it seems most likely that this sketch plan was made during May 1964 or shortly thereafter. The parking lot and connecting walkway are the same as those shown in the grading study. A note on the plan also states, "all existing trees are saved."<sup>121</sup> Given the resemblance of this proposed parking lot and the parking lot on the JBH property today, it seems reasonable that the James D. Graham plans were accepted. Therefore we may reasonably assume that the parking lot and connected path were installed after May 1964. Though alone this may not seem significant, it is important for understanding the possible disturbance of underlying features which remained from the demolition of the HIH. As the geophysical survey conducted in 2008 did not survey the parking area, we do not know of possible archaeological areas of interest other than through the cartographic evidence.

---

<sup>120</sup> James D. Graham Landscape Architect and Buildings & Grounds Committee. *Rhode Island Historical Society Providence-Rhode Island Grading Study for Parking*. May 1964. [John Brown House Architectural Plans and Manuscripts Collection], RIHS Library Archives.

<sup>121</sup> James D. Graham and Buildings & Grounds Committee. *Rhode Island Historical Society Suggestion for Parking Area*. [John Brown House Architectural Plans and Manuscripts Collection], RIHS Library Archives.

### III. Evidence Related to 2008 & 2009 Excavations

During the 2008 dig season at the JBH, students uncovered foundational features along the northwestern section of the property. This was concurrent with a geophysical survey conducted prior to the 2008 season. Units for the 2009 season were chosen based upon the 2008 geophysical survey and the desire to further explore findings in the 2008 units. This section of the report synthesizes the archaeological and geophysical findings with historical research of the property's landscape history. Most of the findings are related to 2009's Units 6 and 7 which were located on the northwestern side of the JBH yard.

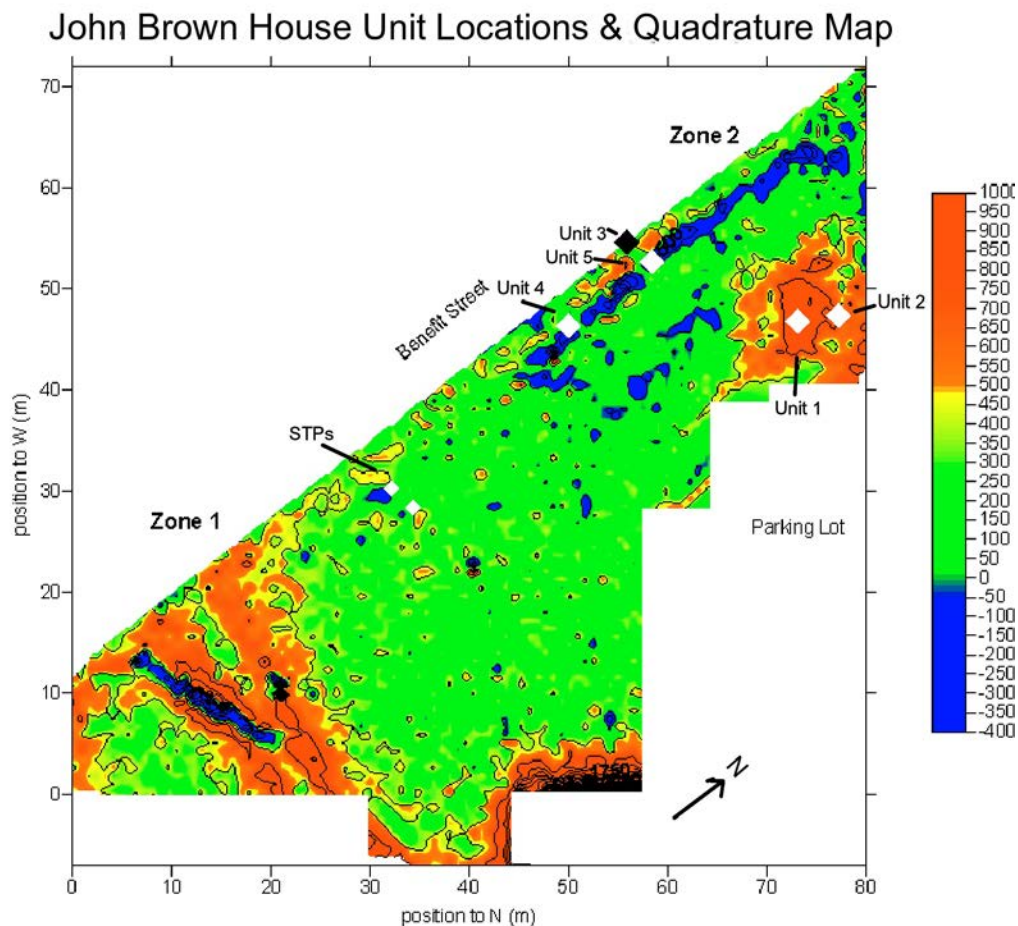

**Fig. 11.** Geophysical Survey of John Brown House Property, 2008. Prepared by Thomas M. Urban.

#### ***JBH 2009 Unit 7***

In the 2008 geophysical survey (**Figure 11**), results showed a large, linear feature in the northwest corner of the yard. It also revealed smaller areas of resistivity throughout the western yard that could

represent underlying features. To investigate one of these smaller areas, student in the 2008 class conducted a shovel test pit (STP) just south of the larger feature. This STP hit what appeared to be stacked stones. To determine if this was a natural or man-made feature, the 2009 class created Unit 7 to expand the 2008 STP. After further excavation, the students discovered that it was in fact a man-made feature, perhaps in the style of a stone wall (see Colburn, Benjamin Unit 7 Summary).

At the beginning of my research, I thought the Unit 7 feature could relate to a fence separating the HIH property from the JBH property. A line dividing the two did not appear in the cartographic evidence until the *1900 Sanborn Fire Insurance Map* (**Figure 6**). At this point, it was unclear if the line represented a physical separation of the properties, or if it was merely the cartographer's preference. Nevertheless, the transcript of a letter from the neighbors to the JBH property, then known as the "Bishop's House" on the corner of Brown and Charlesfield Streets, gives anecdotal evidence of a fence. The letter, which regards a new fence separating the Bishop's House from the JBH is dated to January 1942. The writer states,

To a give a history of the matter, for a hundred years it has been the tradition for the children of the neighborhood to use the terraces of what is now Bishop's House, for coasting [sledding]. As the Robert H.I. Gammell house and stable were then on the corner of Benefit and Charles Field Streets, and a fence divided their grounds from the John Brown House, the slide for the children extended but little farther than where the present little fence stands."<sup>122</sup>

The letter indicates that a fence was constructed to separate the HIH (Gammell) from the JBH. From this I inferred that the feature in Unit 7 was a base structure for just such a fence.

However, the feature in Unit 7 runs roughly north-south. If the maps are accurate, however, the fence would have run roughly east-west, dividing the yards. Similarly, it seems more likely that the fence was constructed primarily of wood. This might explain the wood matter found in the 2009 STP (see Camarillo, Michael Final Report). STP 3 was west of the pergola and is therefore closer to the indicated position of the fence running southwest of the corner with the Bishop's House property. The wood could feasibly have been deposited upon the destruction of the fence under Marsden J. Perry.

This realization still left the nature of Unit 7's feature a mystery. Based off of the research conducted in 2008, it did not appear that any structures were present in the area of the yard containing Unit 7. However, the discovery of the *1875 Atlas of the City of Providence* (**Figure 2**) seemed to indicate that a walkway

---

<sup>122</sup> [Letter from Bishop's House]. January 1942. John Brown House Binder #2 JBH Related Materials, RIHS Library Archives. p.1 of 2.

connecting Benefit Street to the front of the HIH did exist in the general vicinity of Unit 7. Upon reexamination, the *1908 Providence Platbook Map* (**Figure 7**) seems conducive to this hypothesis. Based on the cartographic images it would appear that the walkway ran roughly northeast from Benefit Street. This could explain the more north-south axis of the feature. Unfortunately, since the representation of the walkway only appears on two maps it is difficult to be sure of the walkway's placement with relation to the HIH proper. Likewise, the differing appearances of the walkways from the 1900 Sanborn map to the 1908 Platbook map complicate further analysis or measurement.

### ***JBH 2009 Unit 6***

To the north of JBH 2009 Unit 7, students dug Unit 6. Unit 6 was an extension of 2008's Unit 5 which was located in Zone 2 of the 2008 geophysical survey (**Figure 11**). The geophysical survey revealed some type of large, linear feature in the north-western corner of the yard. Toward the end of their last day of excavation in 2008, students working on Unit 5 uncovered a large feature. Unit 6 was created to further investigate this feature. While we consider this feature to be a section of the foundation of the HIH, Unit 6 uncovered several puzzling finds, which are explored in this section.

The first aspect of Unit 6 which perplexed its excavators was a prominence of gravel in a context *above* the feature.<sup>123</sup> This gravel was visually and textually separate from the rubble fill and debris associated with the destruction of the HIH under Marsden J. Perry. While researching changes to the landscape during and after Marsden J. Perry, I spent significant time examining an aerial photograph of the property, which is most likely from 1949 (**Figure 12**).<sup>124</sup> This photograph clearly shows the JBH and the pathways on the western side of the house, including the staircase from the terrace to the lower yard. Also visible is a path, either man-made with materials or through frequent foot traffic, leading from the staircase to the north and south.

---

<sup>123</sup> That is, the gravel was found in JBH 48 while the feature was fully uncovered in JBH 61/Feature 3. See Merchant, Elise, Unit Six Summary.

<sup>124</sup> Avery Lord of Providence. . [April 1949]. [aerial photograph]. John Brown House Binder #3 JBH Exterior, RIHS Library Archives. The photograph is most likely from April 1949 as Binder #3 also contained a similar photograph taken of the property which was also attributed to the Avery Company. This second photograph was dated April 1949. Given that the photos were taken by the same company, feature similar style, and show the same cars surrounding the property, it seems most likely that the photographs were taken at the same time.

Upon first examination, I believed that the rounded, lighter line along the northwest corner of the yard was somehow related to archaeological remains of the rounded outcropping of the HIH. However, a photograph featured in the December 1935 issue of *The Monograph Series* (**Figure 13**), illustrates that the path leading from the staircase in the yard was designated by gravel.<sup>125</sup> Armed with clear evidence that the path was gravel, I reexamined the aerial photograph, hypothesizing that the rounded “feature” on the photograph was in fact part of the path which meandered through the north and west of the yard. Based then on a comparison of the aerial photograph with the geophysical survey, I suggest that the gravel path was constructed on top of the HIH western foundation wall, which was demolished sometime between 1923 and 1926.

As for the actual deposition of the gravel below the topsoil, it was most likely covered over when the RIHS built the parking lot which is present today along the northeast corner of Charlesfield Street yard. The gravel found in Unit 6, and present in the photograph from 1935, might be the same as the gravel found in Unit 8 from the 2009 season. The gravel in Unit 8 appears to be filling a large hole, perhaps even an old well, to the west of the JBH carriage house (see Seiden, Andrew Unit 8 Summary). If this is the case, the gravel in Unit 8 would have been installed sometime during Marsden J. Perry’s time.

Another puzzling find in Unit 6 were several cobblestones and pieces of asphalt. The appearance of cobblestones and asphalt in Unit 6 is unexpected based on the unit’s proximity to the western wall of the HIH and separation from both Benefit and Charlesfield Streets, which might otherwise have explained the materials. However, I suggest that the cobblestones and asphalt are remains of the most recent driveway of the HIH. This is presuming that the dashed lines and color variations of the area between the HIH proper and its large outbuilding, as shown in the *1900 Sanborn Fire Insurance Map* and the *1918 Providence Platbook Map*, is a driveway. Materials from this driveway could then have been deposited when Marsden J. Perry leveled the house and the outbuildings to extend his yard. Given the gradation of the property, it is plausible that materials would have been deposited downhill from the possible position of the driveway.

---

<sup>125</sup> Russell F. Whitehead, ed. *The Monograph Series: Records of Early American Architecture as Source Material*, A-I-A, Monograph One- Volume XXII- “Providence, Rhode Island” Pencil Points for December 1935 p. 650. Found in the RIHS Library Archives, “John Brown House Historic American Buildings Survey Photographs and Manuscripts,” Collection.



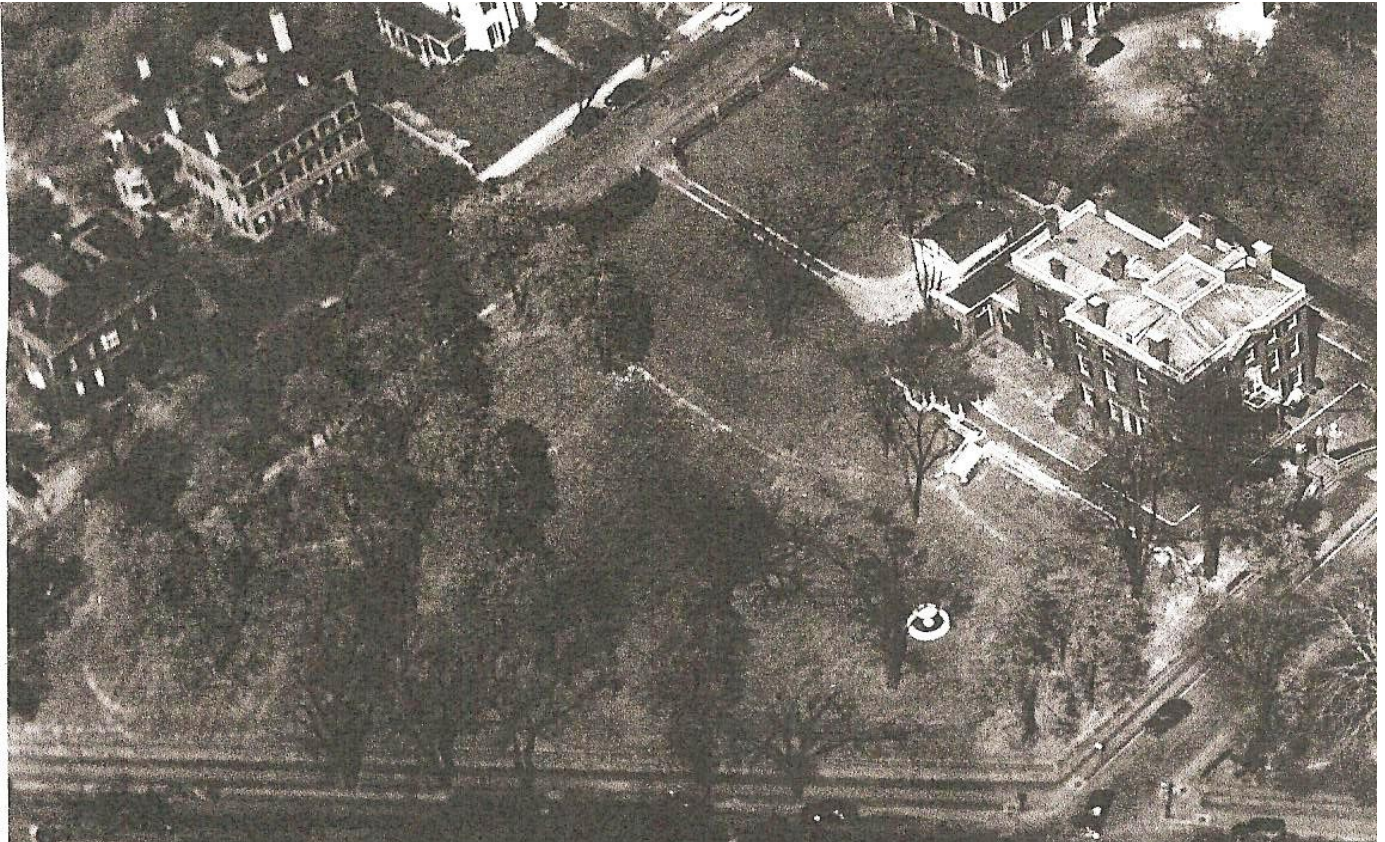

**Fig. 12.** *[aerial photograph], [April 1949]. Avery Lord of Providence.*  
This aerial photograph of the property indicates a light-colored pathway ran through the yard, originating from the staircase west of the house. The fountain is the circular feature west of the house.



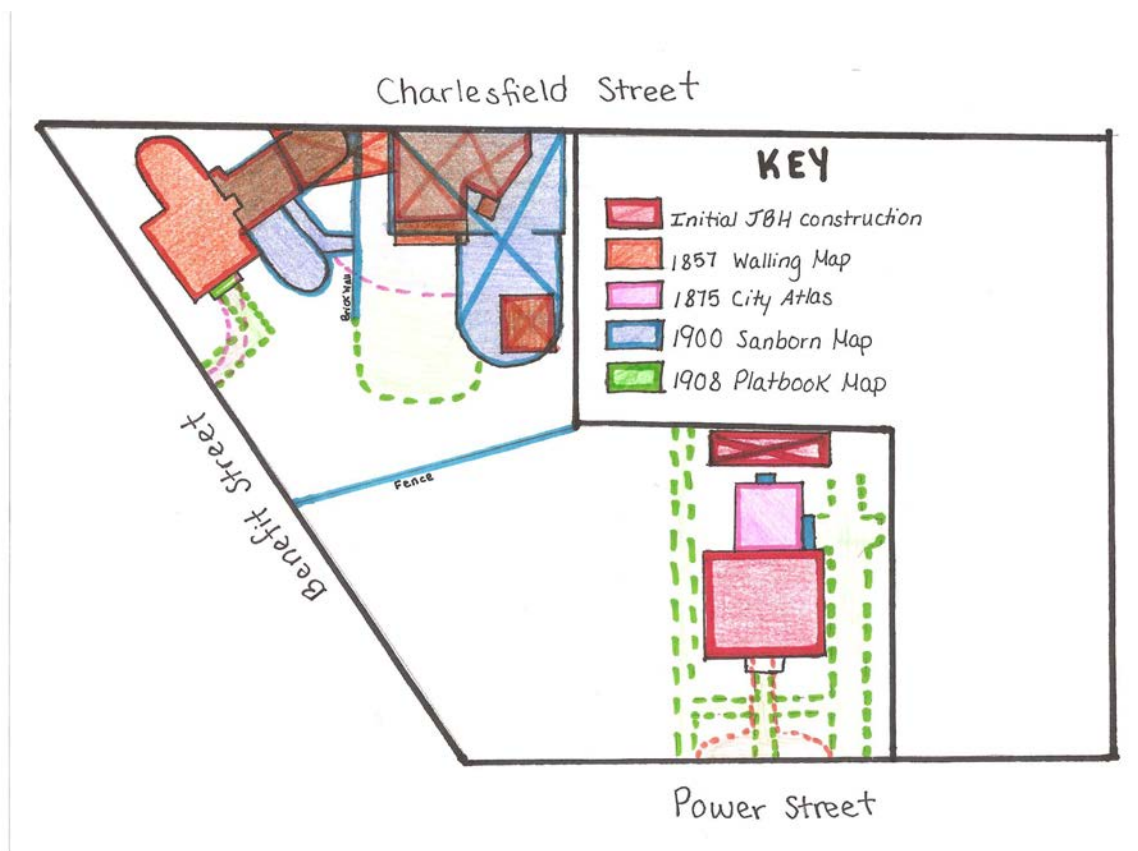

**Fig. 13.** . *The Monograph Series: Records of Early American Architecture as Source Material, A-I- A, Monograph One- Volume XXII- "Providence, Rhode Island" Pencil Points for December 1935.* Edited by Russell Whitehead.

The bottom right corner shows the path leading from the staircase consisted of a light-colored gravel, though it is difficult to ascertain in this particular reproduction.

## **Summary and Table of Structures**

This report concludes with a table listing all structures and features once present on the John Brown House property as evidenced by maps and other primary resources. The information contained within this report explains the evidence for structures and outbuildings prior to 1857. Using cartographic evidence, supplemented with other sources when available and/or necessary, I then described the changes over time to the property and its structures. I then synthesized this research with the excavation findings of the 2008 and 2009 seasons in an attempt to contextualize certain finds. Certainly, more research is needed to provide a complete picture of the landscape change over time. However, the information contained within this report brings us one step closer to understanding the role of the individuals, structures, and features once present at the John Brown House.



Map illustrating the changes to the property over time, according to date of first appearance on other cartographic evidence. This map is not drawn to scale.

#### Works Cited

- Avery Lord of Providence. [April 1949]. [Aerial Photograph]. *John Brown House Binder #3 JBH Exterior*, Rhode Island Historical Society Library Archives.
- Atlas of the City of Providence and Environs*. Philadelphia: Hopkins, 1882. Rhode Island Maps Collection, Rhode Island Historical Society Library.
- Bromley, George W. 1875. *City Atlas of Providence Rhode Island and Parts of East Providence*. Rhode Island Historical Society Library Cartography Collection.
- Graham, James D. and Buildings & Grounds Committee. May 1964. . *Rhode Island Historical Society Providence-Rhode Island Grading Study for Parking*. [John Brown House Architectural Plans and Manuscripts Collection], RIHS Library Archives.

Graham, James D. and Buildings & Grounds Committee. [May 1964]. *Rhode Island Historical Society Suggestion for Parking Area*. [John Brown House Architectural Plans and Manuscripts Collection], RIHS Library Archives.

"John Brown House- Census, Tax, Insurance" in the *John Brown House Binder # 2 JBH Related Materials*, Rhode Island Historical Society Library Archives.

[Letter from Bishop's House], January 1942. Page 1 of 2. John Brown House Binder #2 JBH Related Materials, RIHS Library Archives.

Pezzera, L. Candace. "Rhode Island Historical Society Information for Volunteers: The House of John Brown," revised February 1991. John Brown House Binder #4 JBH General Information and Descriptions: Room by Room, John Brown House Museum.

*Providence Platbook Maps 1875, 1908, 1918, 1926*. Compiled and published by G.M. Hopkins Co., Philadelphia. Recorder of Deed and Land Evidence and City Hall Archives Office. Providence City Hall, Providence, RI.

*Sanborn Fire Insurance Maps*. 1889, 1900. John Hay Library.

*Sanborn Fire Insurance Maps*. 1921. Rhode Island Historical Society Maps, Rhode Island Historical Society Library.

"To illustrate different ownership of the land as bounded by Benefit, Power, and Charles Field Streets. (2)."

[Unattributed], Vol 7 p-51. *John Brown House Binder #4 JBH General Information and Description; Room by Room*, John Brown House Museum.

Urban, Thomas J., preparer. 2008. *John Brown House Preliminary Geophysical Survey Report*.

<<http://proteus.brown.edu/archaeologyofcollegehill/6499>> Accessed December 14, 2009

Walling, Henry E. 1857. *Map of the City of Providence*. Cartography Collection, Rhode Island Historical Society Library.

Whitehead, Russell F, ed. *The Monograph Series: Records of Early American Architecture as Source Material*, A-I-A, Monograph One- Volume XXII- "Providence, Rhode Island" Pencil Points for December 1935 p. 650.

## **CHAPTER 10 Walking Tour of the Archaeological Landscape of the John Brown House**

Bridget Smith

Archaeologists hold an unusual perspective on their field. Whatever they study needs to be carefully considered with a thought to impartiality, but the finds are still filtered, by necessity, through their existing knowledge and experiences. By contrast, the public, who do not approach the results with the same determinedly neutral, highly-researched background, often hold a curiosity tempered with an attachment to the subjects of study. Whether it is their ancestors, their city's history, or the lure of a foreign culture, visitors are drawn to a site for the same reason that archaeologists are, and they have no need to filter out pre-existing notions. It is our responsibility as archaeologists to make our findings available to anyone who might be interested, which makes public presentations such as mine a necessity, especially when made accessible to those without advanced degrees in archaeology. In making this walking tour, I tried to keep in mind the perspectives of visitors to the John Brown House, whether they were emotional, intellectual, or physical.

John Brown, despite his local and national importance, is not a particularly well-known historical figure. Many of the visitors to the John Brown House will be Rhode Islanders, who have a great fondness for this tiny state and its history. Others, as we learned on our tour of the John Brown House, are southern Baptists looking for the "tree that ate Roger Williams", another group with a vested interest in the site. Because the John Brown House will never draw international crowds, I did not feel the need to make the walking tour into a weighty and instructional affair. Rather, I attempted to appeal to the visitors' natural curiosity about both the site and about archaeology itself. I infused the tour with humor (or attempted to, in any case) in order to make it seem more personal and to introduce visitors to the side of the field that all archaeologists know exists but few others do. Furthermore, I wanted to give the visitors an experience of the wonder that archaeologists can feel when holding an artifact or imagining the memories of a location, so I asked them to remember the appearance and existence of the Hale Ives House when they were standing in its former location. My primary goal in creating this walking tour was not to educate, but to give the visitor a personal connection to the John Brown House and our work there.

However, the goal of any historic site is to educate, and this fact combined with the aim for us as students of learning meant that I needed to include as much information as I found to be prudent. I felt that general dates, locations, important finds, and the significance of all of the above were things that the average visitor would both find interesting and be able to understand. I did not include context or unit numbers, descriptions of techniques, the process of dating, or mentions of artifacts that would not intrigue the average person. Thus, I focused on anomalies, such as the hosepipe in Unit 7, large artifacts like the ceramic electrical insulation from Unit 6, and features, like the wall in Unit 7 or the water main

from 2008. These were things that I felt helped define the site as a whole for visitors who were getting a brief introduction in walking over the land. Furthermore, great detail in such a cursory overview as is necessary in a walking tour runs the risk of being confusing and overwhelming rather than informative, becoming words that pass by the visitor without registering, and once this process of ignoring is begun, it can spell death for overall comprehension. My own personal experience with both walking tours and audiobooks strongly flavored my opinions on what should be included and explained, as I attempted to find the information that would be both intelligible and interesting to those with no experience in the field. Hopefully, visitors will be able to use this walking tour to supplement their tour of the house, understanding all the major points without any more history than they were given on that tour. I wanted to educate and enlighten without forcing visitors to struggle.

My final consideration in creating this walking tour was a purely practical one: what path should the visitors follow? The path that I finally chose may not, it is true, be the most logical one based on our experiences, but the most important thing for me was to be able to direct visitors from one unit to the next without undue explanation or confusing them so that they lost track of the entire tour. Thus, I began at the most practical, simplest location: the front door of the John Brown House. I used familiar landmarks to situate the visitor and directed them to sites that were easy to articulate and place, like the parking lot entrance. The path ultimately describes a large loop through the northern half of the yard and, when I walked the route myself, I found that it creates its own sense, progressing from the main house to the Hale Ives House, and finally touching upon other archaeological features of the site. I hope that visitors will find it similarly easy to follow.

This walking tour was intended to accompany a tour of the John Brown House itself, preferably following it as an addendum containing further information and experiences. I kept it brief, under ten minutes, and much of that time is spent walking between sites, so that visitors would not be deterred by our New England winters from partaking in this tour. Furthermore, much preliminary explanation is offered on the walk from one site to the next so that visitors are not standing at a nondescript location with nothing to look at for extended periods of time. Hopefully, this tour can be offered either as a download for visitors before they arrive at the John Brown House or as extra entertainment for those who visit without having considered the possibility. I strove to make archaeology and its findings available to the public and to bring the past into the front of their minds. New Englanders take great pride in the age of their cities relative to those in the rest of the country, and visitors to a Providence archaeological and historical site will certainly appreciate the age and the change over time.

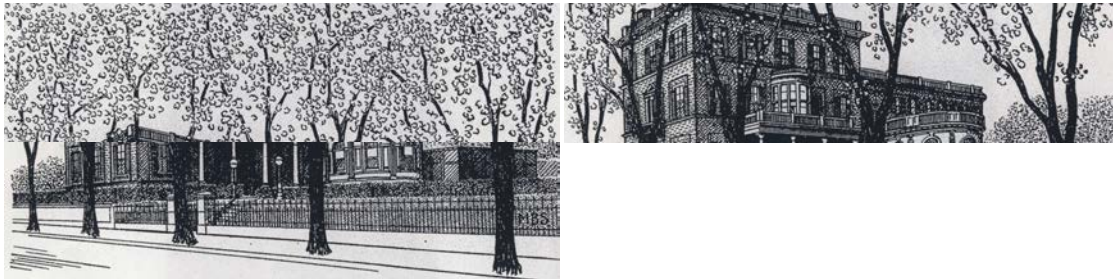
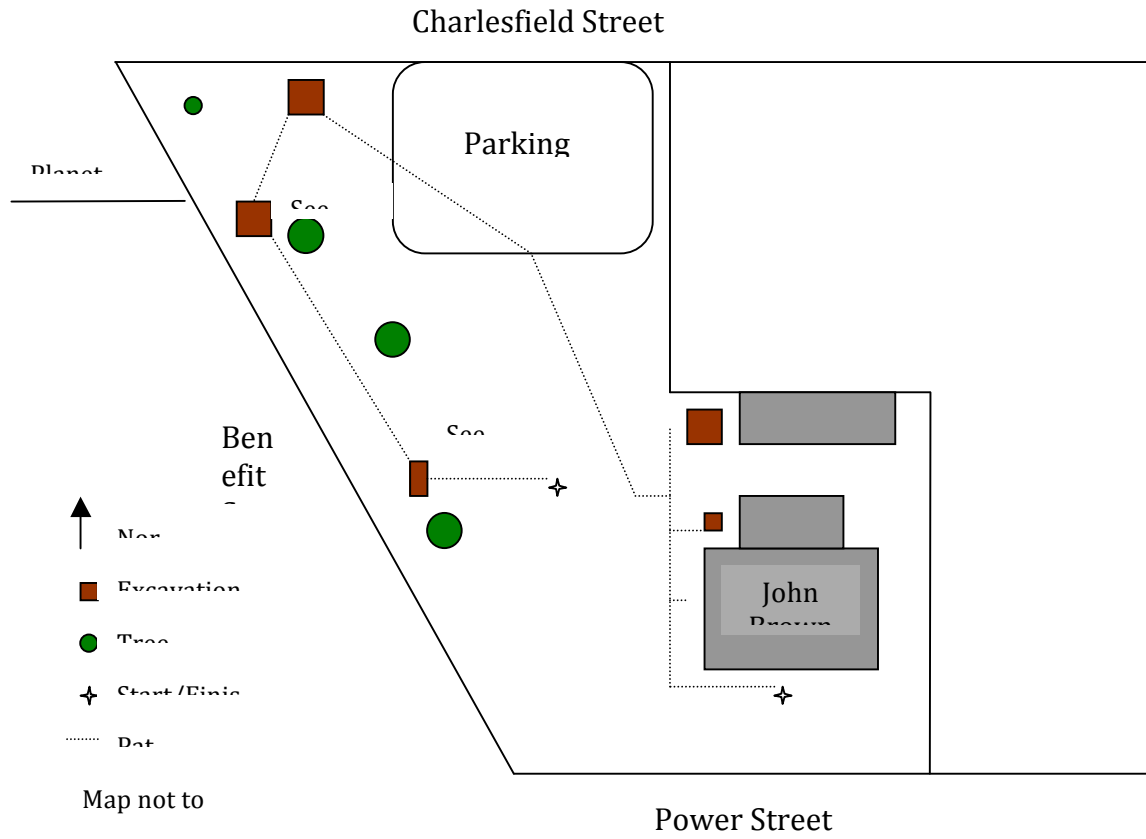

Hale Ives Homestead  
View from Benefit St.  
C. 1900





Photo 1

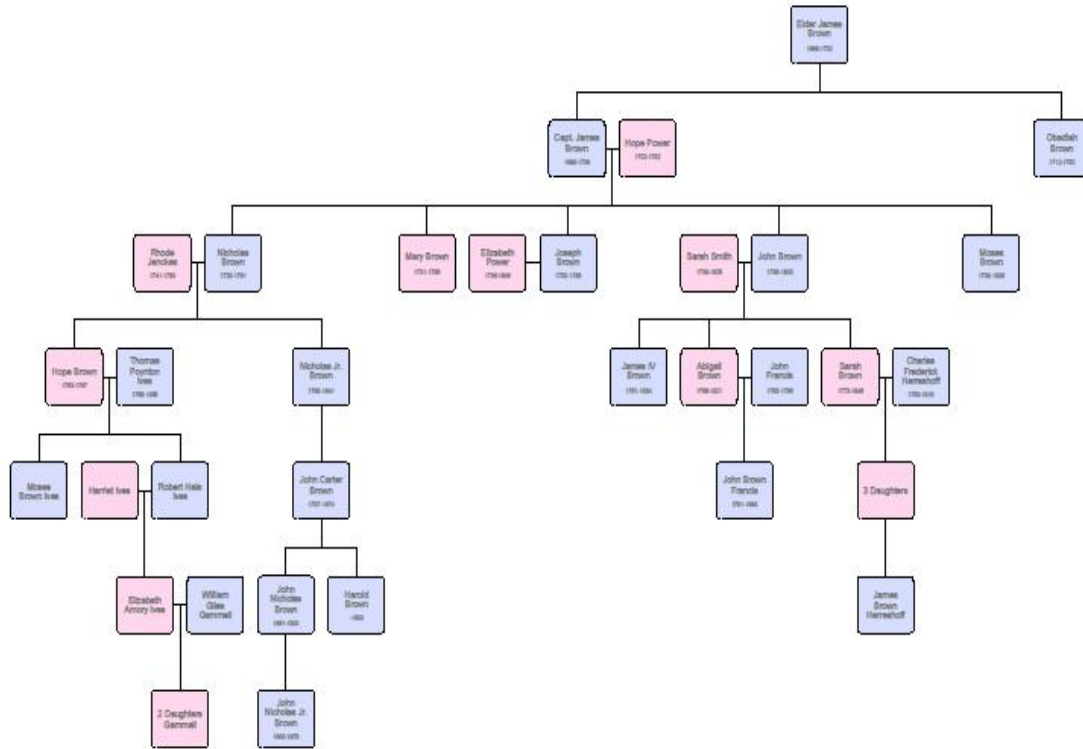

Photo 2 **Under the Hill**



Condensed John Brown Family Tree

# John Brown Family Tree



## CHAPTER 11 OBJECT BIOGRAPHIES

### SOLO-cup | Dime | Wire Nail

Siham Abed

#### Solo Cup Fragment: Unit 7, Context 45

A brief glimpse of this artifact and it is still highly recognizable as a fragment from a red Solo Cup. These disposable plastic cups are infamous on college campuses nationwide for their activity in aiding in the consumption of alcohol.



This artifact was the only one of its kind in Unit 7. It was found in context 45, but no other contexts revealed any other fragments. The artifact is about three centimeters long and about two centimeters wide at its largest point. One side is white while the other side is a vivid red color. This piece is not well worn, possibly indicating that it was freshly placed, perhaps within the past couple of years.

In the 1930s, Leo J. Hulseman founded the Paper Container Manufacturing Company in Chicago, Illinois.<sup>126</sup> However, according to the Solo Cup Company's webpage it wasn't until the 1970s when the "signature red plastic cold cup" was introduced. This proves to be quite diagnostic, as the fragment could not have existed prior to 1970.

The Solo Cups are sold to major retailers, such as Wal-Mart and Whole Foods, but they can also be purchased from nearby the John Brown House. Just on Thayer Street there are multiple stores that sell these cups: CVS Pharmacy, Tedeshi, and the Mini-Mart, to name a few. On campus these cups could be purchased from Josiah's as well as the Campus Market.

---

<sup>126</sup> <http://www.solocup.com/soloabout/aboutHistory.html>

Clearly, these cups can be purchased anywhere, and are sold in various qualities. A small get together, a beer pong tournament, or a fraternity party could ensure the handling of one of these cups. Thus, its particular origins are unknown as there are far too many possibilities.

This fragment does give us some insight into the use of the John Brown House. Brown University does not use red Solo Cups at their affairs, rather clear plastic cups bearing the university coat of arms are utilized. Therefore, it is a safe assumption to make that an official Brown University party was not held on the grounds.

It seems that this fragment made its way onto the John Brown House property without University notice. Perhaps a college student was walking the grounds with their cup and dropped it, or as Unit 7 is quite close to Benefit Street, perhaps someone threw it over on to the property.

Either way, the cup was littered. The modern debris allows the possibility that the John Brown House yard may be a play of exploration for some members of the university or passersby. This could be important in determining why other modern artifacts have been discovered in just JBH45 alone, such as a cigarette filter and a 2001 minted dime.

#### **Dime Minted in 2001: Unit 7, Context 45**

Yet another distinguishable artifact is the 2001 Dime. This dime features the head of Franklin Delano Roosevelt on one side and an image of an olive branch, torch, and oak branch, symbolizing peace, liberty, and victory, on the obverse side. Production of these coins began in 1796, following the Coinage Act of 1792.<sup>127</sup> The dime itself is worth 1/10 of the United States Dollar.



---

<sup>127</sup> "[Federal Reserve Bank of Philadelphia: Money in Colonial Times](http://www.philadelphiafed.org/education/resources/money-in-colonial-times/#06)". Federal Reserve Bank of Philadelphia. <http://www.philadelphiafed.org/education/resources/money-in-colonial-times/#06>. Retrieved 2008-04-02.

The Roosevelt Dime, as it is colloquially dubbed, began being minted in 1946. Legislation was put into place in 1945 to have the Mercury dime be replaced by Roosevelt's likeness.<sup>128</sup> To this day the dime is still minted with Roosevelt's image.

The "P" right about the year 2001 indicates that the dime was minted in the Philadelphia Mint, in Pennsylvania. In this year, 1,369,590,000 dimes were minted in the Philadelphia Mint alone. The dimes are made out of cupronickel, an alloy containing mostly copper and nickel, but also trace amounts of manganese.

When freshly minted the dime should appear a shiny silver color. However, this dime has clearly gone through some weathering. Rust-colored and slightly worn, the dime still has its characteristic ridges. A dime should have 118 of these ridges.<sup>129</sup>

Perhaps the dime has become so rusted from its constant existence in the earth. The constant weathering it must endure has had a negative effect on its original silver finish. This variable color is helpful in determining how long the dime was buried. As cupronickel is well known for its highly resistant nature against saltwater, it may be an indication that the dime had been buried for quite a while, perhaps years.

Context 45, previously shown to house the remains of a fragment from a Solo Cup, continues to show modern day artifacts. This dime, minted in 2001, is one of over a billion dimes minted that year. This is not helpful in determining where exactly it came from, but it does help to reiterate the usage of the property as perhaps recreational to the Brown population and maybe even Providence residents.

### **Wire Nail: Unit 7, Context 45**

Unlike other artifacts, such as coins or stand alone artifacts, nails are littered throughout various contexts of the many units. Nails are usually not unique and offer little insight into the property when they are quite numerous with little individualistic details. This particular piece, indicative of a wire nail, was one of several within the same context.

---

<sup>128</sup> Yanchunas, Dom. "The Roosevelt Dime at 60." *COINage Magazine*, February 2006.

<sup>129</sup> ["Circulating Coins - Dime"](#). The United States Mint. Retrieved September 8, 2009.



There are many other types of nails found around the different units. Wrought nails and cut nails are of an earlier era than the wire nail. In the mid-eighteenth century round-wire nails were produced in Europe.<sup>130</sup> In the early 1850s the wire making machines were brought and set up in New York. They began as small brads, but by the last quarter of the eighteenth century larger, more standard models were produced.

Unfortunately, this nail tells us little else about the context. Nails are littered about anywhere that has ever been under construction, as they are quite small, very inexpensive, and easily forgotten. Therefore, it is safe to say that this particular nail is not indicative of a particular instance.

While most nails were heavily corroded, this one seems to have kept its shape. Perhaps the nail is of more of a modern context, but as it is not the only nail found in JBH45, that may not be true. The nail can not be dated by any other form, except for the general era of its production.

Like leaves that litter the ground in autumn, nails are found in great quantities on historical sites. Fortunately, this wire-nail gives us a relative date of after 1850. The different forms of construction that took place on the property can account for its existence, and therefore it is not an anomaly. In fact, it assures the constant construction and the changing landscape of the John Brown House.

---

<sup>130</sup> Nelson, Lee H. "Nail Chronology as an Aid to Dating Old Buildings," *History News* (Madison, Wis.), Vol. 19, No. 2 (December 1963).



## Pencil | Bottle Cap | Iron Spike

Elise Merchant

### Object Bio: Pencil Fragment from JBH48, Unit 6



A fragment of a pencil was found in context JBH48, of Unit 6. The fragment only contained a wooden portion of the body of the pencil: any sort of inner lead or graphite was absent, as was an eraser or any sort of ending. The pencil was apparently smoothly rounded. The outside of the pencil retained some of its yellowish-orange paint, although the exact original color is hard to determine since the color has clearly been significantly worn away.

Since pencils of this sort (wooden with a yellow coating) are still being used today, as they have been for quite some time, it is impossible to give a *Terminus post quem* for the artifact. For all we know, this might be a modern object. However, we can determine the earliest time at which the artifact had been manufactured, and even make a guess as to the earliest it is likely that the object was deposited, based on what we know about the history of the pencil.

The first “pencils” to be in use were thin sticks of lead which were employed by the Ancient Egyptians and Romans to write on papyrus. Graphite has been used for writing in the place of lead starting sometime between 1500 and 1565, when a large deposit of graphite was discovered in England.<sup>131</sup> The first pencil to be “clearly recognizable” as the precursor to the modern pencil was described in 1565, in Zurich.<sup>132</sup>

The original process for crafting pencils in their modern form (wood casing surrounding a graphite core) started by cutting pure graphite into rectangular pieces. A groove corresponding to the thickness of the graphite was cut into a strip of wood (about the length of the desired finished product, and almost as thick). Then the longest straight side of the graphite rectangle was dipped in glue and inserted into the groove. The graphite which extended above the top of the wood was sawed or broken

---

<sup>131</sup> Wikipedia.org, *Pencil*

<sup>132</sup> Petroski (1989) p. 36



off. More pieces of graphite were inserted in this fashion until the groove had been filled along the entire length of the pencil. Then the top surface of the wood and graphite was flattened, spread with glue, and covered with another strip of wood. After the glue dried the pencil could be cut into the desired shape (round, hexagonal, or octagonal, for example) or left square.<sup>133</sup>

The next innovation in pencil-making came in 1794, when a Frenchman, Nicolas-Jacques Conté invented an alternative to pure graphite, as well as a new method for constructing the pencils. Powdered, pure graphite was mixed with potter's clay and water and molded into leads. Then the leads were inserted into a groove deeper than their own height, and to finish a thin wood piece was placed into the groove on top of the lead.<sup>134</sup> Modern pencils are made with a piece of graphite between two equal halves of wood.<sup>135</sup>

The first pencil factor in America was, according to the Joseph Dixon Crucible Company (which claims to be the first to mass-produce the pencil), the first pencil factory in America was founded by a now-anonymous school girl, around the year 1800. The first lead pencil in the United States was apparently made in Massachusetts by this girl, in partnership with Joseph W. Wade.<sup>136</sup> In 1866, one of the earliest pencil-making machines was patented by Joseph Dixon, the owner of one of the most popular pencil companies. This machine could process the wood for 132 pencils per minute. By the early 1870s, approximately 20 million pencils per year were being used in the United States.<sup>137</sup>

The best way to date this pencil fragment is by the yellow paint. The earliest documentary evidence of yellow pencils dates to 1854, in an art magazine article on pencil making in Keswick, England.<sup>138</sup> At this time, the yellow paint (and paint of other colors) most likely served to cover up imperfections in the wood. Koh-I-Noor pencils, developed in Vienna in 1890 were the first pencils to be known to be characteristically yellow. The stories for the reason behind choosing the color yellow range from the manufacturers' desire to include the colors of the Austro-Hungarian flag (the lead would have provided the black) to the suggestion of the Orient evoked by the color, significant because the Orient was known to yield the highest quality graphite. However, even during the time when the yellow Koh-I-Noor pencil was emerging and gaining a reputation as a high quality pencil, it was more common to finish pencils in dark colors (black, red, maroon, purple, or the natural cedar color).

Yellow Koh-I-Noor pencils were imported into the United States between 1893 and World War I, during which the import was cut off. In 1919, the Koh-I-Noor Company was incorporated in New Jersey.

---

<sup>133</sup> Petroski (1989) p. 61

<sup>134</sup> Petroski (1989) p. 70

<sup>135</sup> Petroski (1989) p. 72

<sup>136</sup> Petroski (1989) p. 93

<sup>137</sup> Petroski (1989) p. 169

<sup>138</sup> Petroski, (1989) p. 138-140

<sup>139</sup> However, the pencil found in JBH 48 is not necessarily a Koh-I-Noor, as there were numerous yellow “imitators”, and yellow is now the most common color of pencil. Today, three quarters of pencils are yellow.<sup>140</sup>

Therefore, the pencil could date from as far back as 1854. However, it is extremely unlikely that the pencil dates from this far back. More realistically, the date range for the yellow pencil found corresponds to the dates when the yellow Koh-I-Noors started to be imported into the United States (which are additionally the dates when yellow imitators would have started to appear): 1893. Based on the location of the find, it could have belonged to someone in the Robert Hale Ives Household, which is entirely possible as the house was constructed by 1857, before the probable earliest date for the pencil. However, given the popularity of yellow pencils throughout modern times, it is equally likely that the pencil came from a more modern individual, perhaps a Brown student studying in the yard of the John Brown House.

### Object Bio: Plastic Bottle Cap Gasket

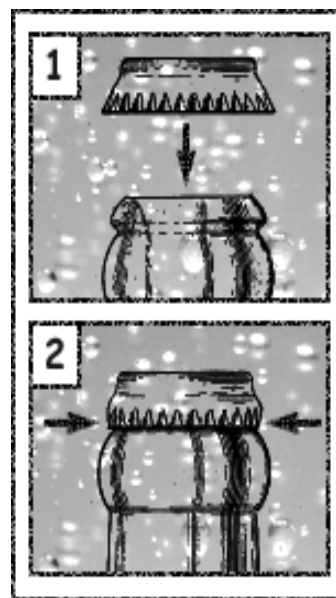

One of the more apparently modern finds in Unit 6 was a plastic gasket from a bottle cap. The gasket was yellowing and eroded in the middle, although the outer ring of thicker plastic was still intact. A gasket such as this one comes from a crown cap. The crown cap was first invented in America, in 1891 by William Painter.<sup>141</sup>

<sup>139</sup> Petroski (1989) p. 191

<sup>140</sup> Petroski (1989) p. 162-163

<sup>141</sup> Inventor of the Week Archive, <<http://web.mit.edu/invent/iow/painter.html>>.

The first known bottle “caps” are cork and wood stoppers, similar to those seen in wine bottles today. The bottle cap started to evolve in the middle of the 1800s, when the use of glass bottles was on the rise. In 1856, the first bottle caps using an insert disk were invented (akin to the one found in JBH 46, although made of cork). These caps were screw caps as opposed to crown caps. The next development in bottle caps was the use of a metal wire attached to the cap to hold the cap down, a trend which was seen between 1856 and 1915.<sup>142</sup>

The original crown cap was a lacquered metal lid with corrugations which would be pressed around the rim of the bottle to hold the cap on, and an internal disk of cork which provided the desired seal. These original crowns were made in apparently only one size, suitable for small bottles, such as for soda and beer.<sup>143</sup> Within 20 years of their invention, crown caps were used on most soft drinks and beer bottles.<sup>144</sup> Not only did Painter invent the crown bottle cap itself, but he worked with bottle manufacturers to create a bottle design which was more compatible with the crown cap.<sup>145</sup> Furthermore, in 1984 he received the patent for the “bottle cap lifter” (more commonly known now as the bottle opener), and in 1898 he received the patent for a foot-powered crowning device to automate the process of sealing bottles. Additionally, Painter founded the Crown Cork and Seal Company, which still today is one of the major manufacturers of bottle caps.<sup>146</sup>

Cork inserts continued to be used in crown caps until the 1960s, when the scarcity of cork materials and the invention of cheaper synthetic materials lead to the switch to plastic gaskets.<sup>147</sup> However, there is not much information available as to exactly when the switch from cork to plastic took place. The information source providing the 1960s date is potentially not the most reliable: the date comes from a website which makes engraved keychains and bottle openers that had a short history of the bottle cap. More reliable sources to date the switch from cork to plastic could not be found. In 1984 a patent was filed for a specific design of soda bottle cap which appears to be the one still in use today, however the patent references “present commercial plastic soda bottles”<sup>148</sup>, and presumably if the bottles themselves were made of plastic then the gaskets surely were, since plastic gaskets are and were even used with glass bottles.

Assuming that the bottle cap gasket came from as far back as the 1960s, it does not appear to be associated with any way to the Hale Ives House, or any other historical occupation of this plot of land. Instead it seems much more likely that the gasket was discarded by a random passerby in modern times.

---

<sup>142</sup> Bottle Cap History: <The Need for Bottle Openers, <http://www.laserengravedkeychains.com/bottle-cap.htm>>

<sup>143</sup> Jones and Sullivan, 163

<sup>144</sup> “Bottle Cap History: The Need for Bottle Openers”, <<http://www.laserengravedkeychains.com/bottle-cap.htm>>

<sup>145</sup> Reinbold, Joan, “Who Invented Bottle caps?”, <<http://www.beermasters.com/content/beer-trivia/who-invented-bottle-caps>>

<sup>146</sup> Inventor of the Week Archive, <<http://web.mit.edu/invent/iow/painter.html>>.

<sup>147</sup> “Bottle Cap History: The Need for Bottle Openers”, <<http://www.laserengravedkeychains.com/bottle-cap.htm>>

<sup>148</sup> U.S. Patent Number 4,476,987, Oct. 16, 1984

This object is one of the two decisively modern objects found in context JBH 46, the other being a piece of a plastic hot- beverage lid (see the object bio by Alyssa Thelmanique). Due to these two objects, we know that this context was deposited in modern times. The other objects found in the context were a stake, colored glass, a piece of a measuring cup, plastic beads, pieces of brick, a piece of unidentified rubber, whiteware and creamware. All of these items are potentially modern, although some of them could date back to earlier times and have been redeposited.

**Object Bio: Wire Spike from JBH48, Unit 6**



The spike pictured above was found in context JBH48 of Unit 6. This spike was the only one found in this context, and is larger than any of the other nails found in Unit 6. Spikes are distinguished from other nails based on their size: a nail that is longer than 10 cm. This particular spike is approximately 11.5 cm long, or 30d in the nail “penny size”. The “penny size” comes from the old English custom of selling nails by the hundred, where the size of the nail determined the number of pennies one hundred nails would cost.<sup>149</sup>

Nails provide a good way to date a stratigraphic layer, as the history of nail-making is fairly well documented. Up until the end of the 1700s and the beginning of the 1800s, nails were individually hand-wrought by a blacksmith or “nailer”.<sup>150</sup> These nails were made from a square iron rod, crafted by a “slitter” which was heated then driven to a point, with a head then formed with blows from a hammer.<sup>1,2</sup> The “slitting mill”, a machine for cutting the iron rods into the necessary size and shape to be crafted into a nail by a nailer was invented in 1590.<sup>2</sup> In 1790, Jacob Perkins invented a nail-making

---

<sup>149</sup> Wikipedia.en.org, *Nail (fastener)*

<sup>150</sup> Visser (1996)

machine which could mass-produce nails at a rate of 10,000 per day, and in 1791 Sam Briggs Sr. and Jr. invented the first cut nail-making machine.<sup>151</sup>

The first kind of cut nail to be produced was the type A cut nail. This was formed by chopping off a piece of the iron bar and “wiggling the bar from side to side with every stroke to produce a tapered shank”.<sup>152</sup> Originally the heads for these nails were made by hand, but machines were developed to craft a head during the era while type A cut nails were still popular, between the 1790s and the 1830s. In the 1820s, type B cut nails were created. These nails were crafted by setting the cutter at an angle and flipping the nail after each stroke. Type B nails were popular between the 1820s and 1900.<sup>3</sup> In the 1850s, machines for making wire nails (the sort most commonly used still today) were invented, however these nails did not gain popularity immediately, and even as late as the 1890s cut nails were used preferentially. The trade-off between cut nails and wire nails is that while wire nails are significantly cheaper, cut nails are harder and sturdier.<sup>153</sup>

The specific nail in question is actually a spike, determined by its size. The approximate date for the spike can be derived from looking at its features and comparing to the known chronology provided by Edwards and Wells in *Historic Louisiana Nails: Aids to the Dating of Old Buildings*. The spike has a square-shaped shaft, with a taper on 2 sides, and appears to be machine made (based on the relative uniformity). These factors narrow the possibilities to nail types 4-10, which give an overall time range of 1792 – 1894. Due to the amount of rust, it is impossible to tell whether the spike is steel or iron, which hinders identification. However, the point of the spike does appear to be rounded in the side view, which would narrow the possible nail types to 4-6, which would give the spike a date range of 1792 – 1847 based on apparent nail type.<sup>154</sup>

Considering that the nail is actually a spike, it wasn't until after 1798 that nails up to 20d in size were mass produced in the Boston area. By 1800 cut nails were commonly available in the Northeast. Additionally, the Burden railroad spike machine, capable of producing 50 spikes per minute, was invented in 1839. However, it cannot be ruled out that the spike was created prior to this date by a less efficient machine. Therefore the time frame for the probable date of manufacture for the nail can be narrowed down to 1798 – 1847.<sup>155</sup>

The John Brown House itself was built in 1786, prior to the probable date for the nail.<sup>156</sup> However, the Robert Hale Ives House, which was located in the area where Unit 6 was dug (in fact, the feature found in Unit 6 seems to probably been associated with the Hale Ives House). This house was

---

<sup>151</sup> Edwards and Wells, p. 15-16

<sup>152</sup> Visser (1996)

<sup>153</sup> Fourshee, *A Two-Bit History of Nails* (1992)

<sup>154</sup> Edwards and Wells, p. 60-61.

<sup>155</sup> Edwards and Wells, p. 17-18

<sup>156</sup> Wikipedia, “John Brown House (Providence, Rhode Island)”

constructed sometime between 1832 and 1857, based on documentary evidence (a deed for the purchase of the land by Robert Hale Ives and a map showing the house, respectively).<sup>157</sup> Therefore, based on the overlap between the time range for the manufacture of the nail and the probably construction of the house, it seems likely that this spike was used in the original construction of the Hale Ives House.

### **Object Bios Works Cited**

"Bottle Cap History: The Need for Bottle Openers." 2003. Laser Engraved Keychains, Web. 30 Nov 2009.  
<<http://www.laserengravedkeychains.com/bottle-cap.htm>>

"Crown Cap." *Inventor of the Week Archive*. January 2007. Lemelson-MIT Program, Web. 30 Nov 2009.  
<<http://web.mit.edu/invent/iow/painter.html>>.

Edwards, Jay D. and Wells, Tom. Historic Louisiana Nails: Aids to the Dating of Old Buildings. Baton Rouge, Louisiana: Louisiana State University: Geoscience Publications, 1993.

Fourshee, Paul. "A Two-Bit History of Nails." *The Blueprint*. 1. 1992. Web.  
<[http://www.fourshee.com/history\\_of\\_nails.htm](http://www.fourshee.com/history_of_nails.htm)>.

Jones, Olive, Catherine Sullivan, George L. Miller, E. Ann Smith, Jane E. Harris, and Kevin Lunn. The Parks Canada Glass Glossary. Revised ed. National Historic Parks & Canadian Parks Services Sites Environment Canada, 1989.

Nolan, Robert L., "Bottle Caps". U.S. Patent number 4,476,987. 7 December 2009.

"Nail (fastener)." *Wikipedia, The Free Encyclopedia*. 30 November 2009. 5 December 2009.  
<[http://en.wikipedia.org/w/index.php?title=Nail\\_\(fastener\)&oldid=328708327](http://en.wikipedia.org/w/index.php?title=Nail_(fastener)&oldid=328708327)>.

"Pencil." *Wikipedia, The Free Encyclopedia*. 21 Nov 2009. 9 Dec 2009.  
<<http://en.wikipedia.org/w/index.php?title=Pencil&oldid=327139485>>.

Petroski, Henry. *The pencil*. Alfred a Knopf Inc, 1990. Print.

Reinbold, Joan. "Who Invented Bottle Caps?." *Beer Masters: Beer Talk for Beer Lovers*. 2009. Beer Masters, Web. 30 Nov 2009. <<http://www.beermasters.com/content/beer-trivia/who-invented-bottle-caps>>.

Visser, Thomas D. "Nails: Clues to a Building's History." *UVM Historic Preservation Program*. 1996. Web.  
<<http://www.uvm.edu/~histpres/203/nails.html>>.

Yellin, Steffi. "Historical Background of the John Brown House Property". John Brown House Archaeological Report 2008. The Archaeology of College Hill Website.  
<<http://proteus.brown.edu/archaeologyofcollegehill/6292>>.

---

<sup>157</sup> Yellin, Steffi, John Brown Hosue Archaeological Report 2008, p. 31

## Porcelain | Penny | Pipe Stem

Laura Sammartino

### Porcelain



The two small porcelain fragments were discovered in JBH 57 from Unit 8. The artifacts, which appear to have come from the same vessel are classified as Polychrome Chinese Export Porcelain whose dates of production range from 1680-1850. The defining attributes of this type of porcelain, as defined on the Florida Museum of Natural History's digital type collection database, are as follows, "White, thin, highly vitreous paste that is smooth and translucent. [The] background glaze is well bonded to the paste, white or bluish-white in color, lustrous, and with little evidence of imperfection. [The porcelain is] decorated with opaque overglaze enamels and gilding in a variety of colors, including multiple shades of green, pink, blue, red, black, plum orange and yellow.

Design motifs usually include floral elements combined with animals, birds, insects, geometric designs, symbols and figures. Motifs are detailed and finely executed." Common vessel forms of this type of pottery include bowls, cups, plates, saucers, and tea pots. Chinese porcelain from this category can be more narrowly dated based on the color palettes and motif themes. These sherds seem to be of the "Famille Rose" palette which is "distinguished by its predominantly floral design featuring clear, bright, pink roses detailed in white, and dates between ca. 1720 and 1850" (FLMNH).

Ceramics are highly informative pieces of material culture to archaeologists. Although pottery is fragile, it is virtually indestructible, as fragments are highly resistant to discoloration and corrosion thus remaining similar to their original appearance (Deetz 68). Deetz describes three general classes of pottery, which include the earthenware ("soft, water-absorbent body made impermeable by glazing"), stoneware ("hardbodied pottery that does not absorb water") and porcelain ("highly vitrified white ceramic made from a special class—kaolin—and is hard and impermeable to water.") (69-70). These three classes of pottery are found on most historic sites. Ceramics are also largely utilitarian in function. Through the study of ceramics archaeologists can determine much about the life of their owners.



Porcelains were invented in China and were exported on ships with other cargo including tea, silks, paintings, lacquerware, metalwork, and ivory. Porcelain cargo was generally stored at the lowest level of the ships to provide ballast and because they were resistant to water. Popularity of polychrome overglaze was heavily influenced by European interest in porcelain decorated with coats of arms in the 18<sup>th</sup> century. The polychrome enamels made this possible as they allowed for extreme detailing, which the typical monochrome cobalt blue palette did not.

Before 1660 in America pottery was essentially uncommon. The pottery that was available was almost entirely imported from England. There was local production of pottery in America, specifically in Virginia and New England. However the markets for the ceramics were local and the production was limited (Deetz 79). After American independence in 1784, the country officially entered into trade with China. Therefore, porcelain is highly unusual in historic sites before the nineteenth century, unless the site had merchant ties (86). The American trade and demand for porcelain helped revitalize the export porcelain industry of China which had been suffering since the creation of porcelain factories in Europe at the beginning of the 18<sup>th</sup> century ([www.metmuseum.org](http://www.metmuseum.org)).

The recovered pieces of porcelain from JBH57 are of the Polychrome Chinese Export type, more specifically the “Famille Rose” palette. The nearly rectangular fragment is from the edge or rim of a vessel and is 10.2mm in length and 5.6 and 7.7mm in width and is 1.4 mm thick. The thicker (2.5 mm), triangular fragment has sides of 13.7 mm and 12.5 mm and a hypotenuse of 17.9 mm. The hand painted design in pinks and greens depicts a floral motif of bright pink roses. Only one side of the fragments are painted. Therefore, the fragments are most likely from a plate or a saucer, as those would only be seen from one angle. Due to porcelain’s costly nature it usually serves a socio-technic function, as plates were commonly put in cases on display and handled with care or perhaps used during tea time (Deetz 81).

The fragments were found on November 2, 2009 in the same context as a 1946 Lincoln One Cent. The porcelain is much older than the penny, with possible dates of production ranging from 1720-1850. Many ceramic sherds including other pieces of porcelain were found in Unit 8; one possible explanation for the abundance of the utilitarian artifacts being the close proximity to the house. The porcelain was most likely owned and utilized by the owners of the house for either the purpose of display or the functional purpose of drinking and eating. Additionally, the abundance of porcelain coincides with what is known about the Browns. The Browns were a prominent merchant family in New England and traded with various lands, including China.

## Penny



The 1946 Wheat Penny was found in JBH 5, corresponding to Unit 8. The United States Mint refers to this type of coin as the Lincoln head cent, appropriately named to reflect the portrait of Abraham Lincoln on the obverse of the coin. The coin is 19.05 mm in diameter and 1.55 mm thick (US Mint).

The United States government first authorized the minting of the penny, the first currency of any type to be authorized, in 1787, and since then the penny's design has "symbolized the spirit of the nation from Liberty to Lincoln" ([www.pennies.org](http://www.pennies.org)). Since the time of the penny's authorization over 300 billion pennies have been minted with 11 different designs. The portrait of Abraham Lincoln, first appearing in 1909 commemorated his 100<sup>th</sup> birthday and replaced the Indian cent which depicted an Indian princess on the obverse. The new design was the first coin to feature a historic figure and the words "In God We Trust". In addition to the changes in design, the composition of the penny has also been altered. The first penny minted in 1787 was 100% copper. This pure composition was prevalent until the mid 1800's. During the time of World War II the composition was 95% copper and 5% zinc ([www.ustreas.gov](http://www.ustreas.gov)). 1946 pennies were minted in one of three places, including Philadelphia, Denver and San Francisco. The place of minting is identified by a letter, however coins produced in Philadelphia traditionally carried no mark at all. The 1946 penny uncovered in JBH57 is badly worn, making it impossible to distinguish a mark or therefore, the place of production. Philadelphia produced the most pennies, 991,655,000, Denver (D) minted 315,690,000 and San Francisco (S) minted 198,100,000 ([www.coinfacts.com](http://www.coinfacts.com)). The penny has been produced in larger quantities than any other denominations. [http://www.coinfacts.com/small\\_cents/lincoln\\_cents/wheat\\_ear\\_cents/1946\\_cent.htm](http://www.coinfacts.com/small_cents/lincoln_cents/wheat_ear_cents/1946_cent.htm)

The simple design on the reverse of the coin depicts "two wheatheads in memorial style. Between these, in the center of the coin, are the denomination and UNITED STATES OF AMERICA, while curving around the upper border is the national motto, E Pluribus Unum, which means "One out of

Many." The initials of the artist, VDB, were also engraved on the reverse of the penny ([www.ustreas.gov](http://www.ustreas.gov)).

The penny was uncovered November 2, 2009 from JBH57. The penny was badly worn and corroded, most likely from years of being buried in the soil—soil that was often saturated with water. Also, found in context 57 were noncontemporaneous fragments of Polychrome Chinese Export porcelain of the Famille Rose palette. These porcelain artifacts were produced for over 100 years, from 1720-1850. However, their period of use is likely to have extended beyond 1850, as porcelain was very costly and often only used for the purpose of display. Therefore, the porcelain was usually handled with care and kept in very good condition. The penny on the other hand, clearly did not come from the same owners as the porcelain. The porcelain owners were most likely the Browns, since the dates would correspond to the years the Browns inhabited the house. The earliest possible date of deposition for the penny would be 1946, if it was left on the ground the year in which it was minted. However, despite the accurate date of production for the penny, one cannot possibly determine when it actually entered the archaeological record, other than to say it could not have been before 1946. Therefore, the penny could not have been owned by the Brown's since the family predates the year of production for the penny. Additionally, the penny and the porcelain are very different types of material remains. The penny does not give the archaeologist any information about the owner, as pennies are used by all levels of society. Also, given that the penny is the most widely produced coin in circulation. Thus, the objects greatly differ in value and rarity.

The porcelain was an import to the country, traveling with similar cargo as well as teas, silks, ivory, etc from somewhere in China. The penny was minted domestically, in one of three United States cities. Although the minter's mark was unable to be distinguished after lab work, the penny is known to have been produced in Philadelphia, Denver, or San Francisco. It is most probable that the penny was produced in Philadelphia, as that city produced nearly half of the coins minted in 1946.

It is also important to note that the 1946 penny was found below other older artifacts, such as a pipe stem from JBH43, which dated to 1750-1800. Therefore, the soil and deposits in Unit 8 have since been disturbed, allowing the newer artifacts to be mixed with the older artifacts dating back to the time of the Brown's inhabitation.

[http://www.coinfacts.com/small\\_cents/cents\\_lincoln\\_wheat\\_reverse.html](http://www.coinfacts.com/small_cents/cents_lincoln_wheat_reverse.html)

## Pipe Stem

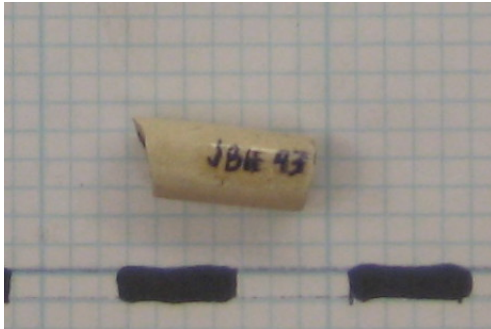

The small pipe stem fragment was uncovered in JBH 43, the first context excavated in Unit 8. The artifact measures 16.2 mm in length and has a diameter of 6.7 mm. The hole in the stem, by which the smoke traveled from the bowl of the pipe to the smokers mouth, has a hole that is 4/64 of an inch in thickness, commonly referred to as a 4. The size of the hole is especially important in dating the artifact with use of the Harrington chart, as a 4 was most commonly in use from 1750-1800. However, a few examples of 4's have been found from the years 1710- 1750. Typically the shape and style of the tobacco pipe's bowl is used to most accurately determine a date for the pipe. The evolution of the bowl is easily recognizable in the clear and documented transitions in style and shape from the 17<sup>th</sup> century through to the 19<sup>th</sup> century. The English archaeologist, Oswald, was the first to study the bowl's evolution in 1951. This kind of dating, using stylistic trends, although more accurate, is frequently impossible due to the scarcity of bowls. In general, more pipe stem fragments are found than bowl fragments. Additionally, the correct identification of maker's marks serves as a third way to accurately date tobacco pipes or fragments.

English Kaolin tobacco pipes were items "manufactured, imported, smoked and thrown away all within a matter of a year or two" (Hume 296). Although the pipes were cheap and thus used by all economic levels of society, the pipes were extremely durable, as the archaeological record is rich with clay pipe fragments. The prevalence of stem fragments on colonial sites has been attributed to the fact that the stems were long and fragile, and therefore were easily broken into numerous pieces.

The tradition of smoking was begun by the Indians and adopted as a fashionable habit in England around the 1570's. By the 17<sup>th</sup> century smoking had become a common practice (Hume 296). The earliest pipes had short stems, 1.75-3.5 inches in length. The length of the stem increased throughout the decades, with some pipes measuring over a foot in length. However, by the 2<sup>nd</sup> half of the 18<sup>th</sup> century it was uncommon for a pipe stem to be longer than 9 inches. Additionally, over the years, as the process of making pipes became more refined thinner wires were used to make the hole and thus pipe holes became smaller and smaller. The earliest pipes in America, dating to about 1600

had bores 9/64 of an inch in diameter (Deetz 27). The reduction in diameter of the bore effectively reduced the “amount of matter transmitted through the stem to the smoker’s mouth” (Deetz 28). Decoration of the pipe stem and pipe bowl also went in and out of fashion. Some stems from the archaeological record were decorated. Decorated bowls were common in the 18<sup>th</sup> century. Less common during this time were glazed or waxed mouth pieces.

After analysis of the pipe stem fragment from JBH43, it is most likely that this diagnostic artifact came from a tobacco pipe that was manufactured and smoked in the second half of the 18<sup>th</sup> century. This interpretation is based on the Harrington study which states that pipes with a bore hole size of 4/64” reached their peak of production between 1750-1800. Since there is no makers mark on the artifact it is difficult to determine the origin of the pipe. The pipe could have been manufactured domestically or imported from England or Holland. Importing tobacco pipes is not unlikely considering the amount of shipping trade undertaken by the inhabitants of Providence and more importantly, the Brown’s, a family of well known merchants. Therefore, the pipe could have been part of a merchant ship’s cargo.

The stem fragment was found on September 21, 2009, the first day of digging. It was discovered in the topsoil of Unit 8, along with wire nail, a tack, a shell fragment, charcoal, some glass, a porcelain sherd, a white ware sherd, and some modern pieces of orange plastic. The range of artifacts from context 43 was interesting to note, as old was seemingly mixed with new (plastic). The nature of the context, including the topsoil, can account for the assortment of artifacts.

The identity of the pipe’s owner is unclear. The various possibilities include the residents of the house, the servants, or any visitors to the John Brown House and yard. The inexpensive nature of the object, along with the fact that smoking was a common habit enjoyed by all levels of society makes determining an owner a difficult and seemingly impossible task.

#### Works Cited

Pipe Stem:

Deetz, James. In Small Things Forgotten: An Archaeology of Early American Life. New

York: Doubleday, 1996.

Hume, Ivor Noel. A Guide to the Artifacts of Colonial America. Philadelphia: University

of Pennsylvania Press, 1969.

Penny:

"Fact Sheet: Currency and Coins." US Department of the Treasury. 18 November 2009

<<http://ustreas.gov/education/fact-sheets/currency/lincoln-cent.shtml>>.

"Lincoln Cents Wheat Ear Reverse." CoinFacts.com - The Internet Encyclopedia of U.S.

Coins. 1 Dec. 2009.

<[http://www.coinfacts.com/small\\_cents/cents\\_lincoln\\_wheat\\_reverse.html](http://www.coinfacts.com/small_cents/cents_lincoln_wheat_reverse.html)>.

"Penny History." Americans for Common Cents. 1 December 2009.

<[http://www.pennies.org/index.php?option=com\\_frontpage&Itemid=1](http://www.pennies.org/index.php?option=com_frontpage&Itemid=1)>.

Porcelain:

Deetz, James. In Small Things Forgotten: An Archaeology of Early American Life. New

York: Doubleday, 1996

"East and West: Chinese Export Porcelain." The Metropolitan Museum of Art, New

York: metmuseum.org. 1 Dec. 2009.

<[http://www.metmuseum.org/toah/hd/ewpor/hd\\_ewpor.htm](http://www.metmuseum.org/toah/hd/ewpor/hd_ewpor.htm)>.

"FLMNH - Historical Archaeology -Type Index Display." Florida Museum of Natural

History. 10 Dec. 2009.

<[http://www.flmnh.ufl.edu/histarch/gallery\\_types/type\\_index\\_display](http://www.flmnh.ufl.edu/histarch/gallery_types/type_index_display)>.

**Electrical Insulation | Whiteware | Drainpipe**

Bridget Smith

**Porcelain Electrical Insulation**

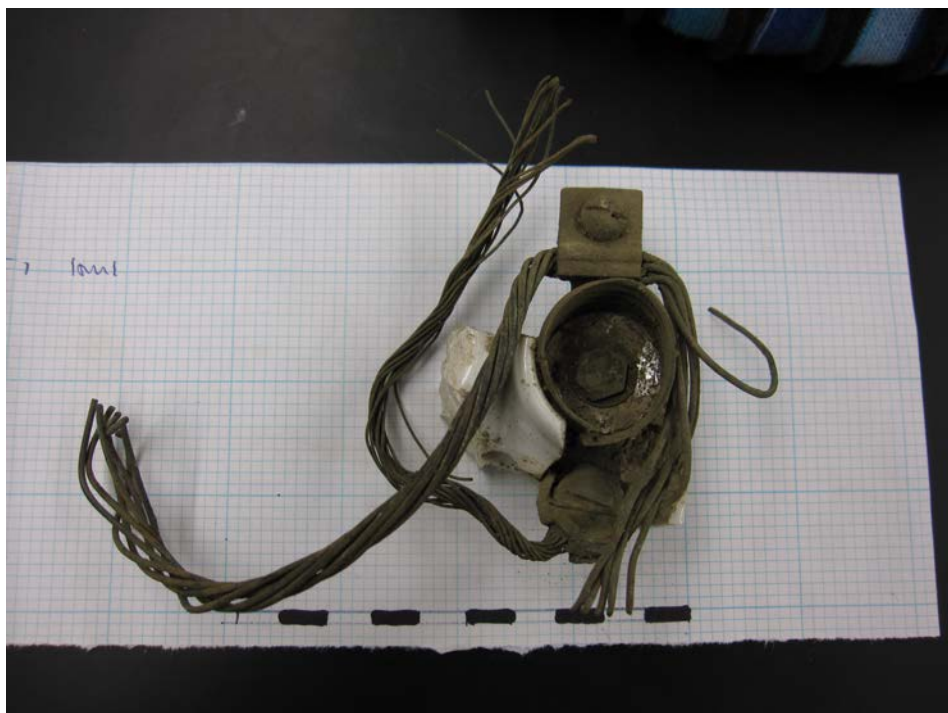



This find, unearthed in Unit 6, context JBH48, consists of three small sherds and one large block of porcelain. Each of these is glazed on at least one surface, and the large block has implanted in it the end of a ridged metal tube as well as two twisted bundles of wire, one of which runs directly into the metal base of the tube, the other of which passes through a clamp raised to the side. The bottom of the large block, while clearly the bottom of the object complete with a raised foot, is unfortunately split in half, leaving the number “35” in relief with no context. Furthermore, one of the small shards fits into the large block cleanly, completing a rough broken edge as a smooth finished one. The ceramic component of the largest block measures 51.5 mm long by 42.6 mm wide by 36.8 mm tall at the tallest point, while the metal cylinder, which has been warped either by a pre-depositional event or by its time in the earth, measures 31.4 mm at its widest point and 24.7 mm at its narrowest. The bundles of metal wires extending from the artifact were measured in three separate measurements, none of which were exact due to the curvature of the fragile wires: the thin bundle is approximately 130.0 mm long, while the two halves of the thick bundle, which passes through a metal bracket, were measured to 71.4 mm and 139.0 mm.

A similar artifact was found during excavations last year, without the metal wires but with the additional words “30 amp” imprinted on one side.<sup>158</sup> This fact, along with the wires in this year’s artifact, indicates that they were both involved in electricity. Indeed, as last year’s was found in Unit 5, a subset of this year’s Unit 6, in which this artifact was found, they may even be parts of the same whole. The most likely possibilities for this artifact are a fuse or an insulator for telephone or telegraph lines.

Glass was the most popular material from which to construct telephone and telegraph line insulators because it was relatively inexpensive in addition to fitting the basic requirements of being waterproof and resistant to electricity and heat.<sup>159</sup> However, like ceramic, glass is an excellent conductor of heat, which makes them both vulnerable to condensation on the inside and the outside of the insulator. The other alternative, hard rubber, was even more of a problem, as long-term exposure to the elements would render the surface rough and porous, leaving it unable to perform its main functions. Thus, glass was the most popular thanks to its low cost. As electricity grew more widespread, however, the greater strength and durability of porcelain were needed in order to construct the larger insulators, like those that can be seen today on telephone poles. From circa 1915 on, nearly all insulators of this type were made from porcelain.<sup>160</sup>

---

<sup>158</sup> Ansel, Evelyn. “Object Biography: Porcelain Fuse.” Archaeology of College Hill: John Brown House Archaeological Report. Ed. Krysta Ryzewski. 2008. p. 167.

<sup>159</sup> Pope, Frank L. Modern Practice of the Electric Telegraph. New York: D. Van Nostrand, 1881.

<sup>160</sup> Berry, Bob. “A Brief History of Porcelain Insulators.” <http://www.insulators.info/porcelain/history.htm> Edited 12/24/1995. Viewed 12/11/2009.

The shape and design of the artifact, however, pose a problem. Modern insulators are essentially stacks of discs. Older insulators could be square, cup-shaped, or tipped with hooks.<sup>161</sup> None of them have the grooved metal cylinder or wires that are found on this artifact, so it seems unlikely that this shard is part of such an insulator. Evelyn Ansel, who studied the corresponding artifact found last year, concluded that it was most likely part of a fuse. This is exceedingly likely, found, as it was, in the remains of a house destroyed in the 1920s, a time when electricity in homes was rapidly expanding. Furthermore, the shape of the ribbed cylinder and the placement of the wires resemble fuses patented around that era. For example, the layout of James J. Woods's electric fuse-box<sup>162</sup>, with the socket in the center and the wire cables extending from each end, is noticeably similar to this small fragment. Furthermore, Providence's own Louis W. Downes patented an electric fuse cut-out featuring a ribbed socket like the one found here.<sup>163</sup> In their patents, both men specified that the fuse would be created out of porcelain, knowing that the ceramic was the preferred material for electrical insulation as described above. In addition, there is a bit of curved porcelain adjacent to the metal cylinder, suggesting a location for another such, perhaps paired with the first. This is not a feature that is found on any kind of telephone or telegraph wire. Furthermore, as the Hale Ives House acquired a telephone connection in 1915<sup>164</sup>, it must have had electricity before that date in order to run the telephone.

Because of the lack of a maker's mark or a brand on the artifact itself and the minimal information that it is possibly to acquire from the rusted, tangled, broken remnants that we have, it is nearly impossible to give this artifact a definite date or location. It is clearly an electrical implement, and the use of porcelain places it around the turn of the twentieth century. It seems more likely to have been a fuse in a private home – likely the Hale Ives House – than to have been an insulator for telephone or telegraph lines.

### Red-Printed Whiteware



---

<sup>161</sup> Guthrie, Mike. "Early and Unusual Telegraph Insulators." <http://www.insulators.info/articles/early/> Edited 11/18/1997. Viewed 12/11/2009.

<sup>162</sup> Wood, James J. "Electric Fuse-Box." Patent no. 736049. Issued Aug. 1903.

<sup>163</sup> Downes, Louis W. "Electric Fuse or Cut-Out." Patent no. 680968. Issued Aug. 1901.

<sup>164</sup> Yellin, Steffi. "Historical Background of the John Brown House Property." Archaeology of College Hill: John Brown House Archaeological Report. Ed. Krysta Ryzewski. 2008. p. 32.

This small sherd of ceramic, measuring 17.5 mm by 15.6 mm by 3.0 mm thick, is a very popular style of dishware dating to the mid-nineteenth century. Thanks to the perfection of creamware in the 1760s, mass-produced ceramics became commonly available at lower prices, greatly increasing the abundance of ceramics in daily life and sherds in the archaeological record, most of which were imported from England, where Staffordshire was the center of production for the American market. Thus, more decorative wares replaced the rougher stonewares and earthenwares which had long produced hardy, heavy-duty vessels for everyday use. Furthermore, this shift aided in the increase of individual dishes rather than communal serving dishes and shared wooden “trenchers”<sup>165</sup>, which marks the developing trend of individual associations with material culture. Around 1800, the appearance of porcelain is noted in well-to-do households; in 1787, John Brown and John Francis sent the *General Washington* on her first voyage to Canton to acquire porcelain, and John Brown continued to be heavily involved in the ceramics trade for many years.<sup>166</sup> Many sherds of porcelain were found in other contexts during the course of our excavation, but this fragment of whiteware would have been a much more common type of pottery, English in origin. Porcelain was likely saved for important occasions and high tea services, while whiteware such as this would have been used more frequently and, therefore, been vulnerable to breakage.<sup>167</sup>

This sherd of whiteware, while too small to ascertain certain details about the dish to which it belonged, can still contribute a great deal of information. For example, red-printed whiteware was produced between the years 1829 and 1850, with its greatest popularity occurring within the first decade of its production: 1829 to 1839.<sup>168</sup> There is a further possibility that it broke off a two-color printed whiteware dish, as just this small fragment of rim does not guarantee either that there is no other color or that it is the only color, and two-color prints often consisted of one color around the rim while another formed the decoration in the bowl of the dish. Two-color transfer-printed whiteware was produced between 1831 and 1846,<sup>169</sup> a range which falls well within the limits of red-printed whiteware production.

Because this sherd is a segment of the rim, there is more information to be pulled from it. Judging by the gradual curve visible in this short fragment, the edge is smooth and not scalloped, which is a later trend in the production of dishware: while scalloped rims were produced from the beginning in

---

<sup>165</sup> Deetz, James. *In Small Things Forgotten*. New York: Anchor Books. 1996. p.82.

<sup>166</sup> Mudge, John McClure. *Chinese Export Porcelain for the American Trade, 1785-1835*. University of Delaware Press, 1981. pp. 112-3.

<sup>167</sup> Deetz, pp. 86-7.

<sup>168</sup> Miller, George L. et al. “Telling Time for Archaeologists.” *Northeast Historical Archaeology*, Volume 29, 2000. Poster produced by the Council for Northeast Historical Archaeology developed by the URS Corporation Archaeology Laboratory.

<sup>169</sup> *Ibid.*

1795, impressed rims were produced from 1825 through 1891 and were popular from 1841 to 1857.<sup>170</sup> While this edge is clearly not impressed, as there are no engravings around the rim, unmolded rims, another unscaloped style, were not produced until 1850, the final year in which red-printed whiteware was produced, so this is likely not an unmolded rim. The dates that mark the heights of popularity for this color and this style rim do not overlap at all, with red transfer prints losing traction in 1839 and with impressed rims becoming more common in 1841, so it is not possible to narrow the date range by combining these two factors.

The sherd is too small, with the segment of rim measuring 12.6 mm, to determine what size the whole dish was. It is clearly a medium-sized dish: the rim is too sharply curved for it to have been a platter but too gently for it to have been a cup or a saucer. However, as most dishes fall into this range, this slight limitation is not of great use.

Unfortunately, while its color, a relatively rare shade, makes it distinctive and established within only a few decades, its small size makes it nearly impossible to discover specifics. For example, not only is there no visible maker's mark, the pattern of decoration is not easily discernible. There is a suggestion of a floral pattern with the sprigs in one corner, but no further interpretation of that is possible. The smooth unscaloped and unimpressed edge appears to be relatively rare, as is the red printing. While this type of ceramic was fairly common in the mid-nineteenth century, the relative rarity of this specific design reminds us that the Brown family was a wealthy one, and John Brown's involvement in the ceramics trade may have contributed to their assortment of ceramic dishes.

### **Fragment of Drainpipe**



<sup>170</sup> Stelle, Lenville J. *An Archaeological Guide to Historic Artifacts of the Upper Sangamon Basin*. Center For Social Research, Parkland College. 2001. <<http://virtual.parkland.edu/lstelle1/len/archguide/documents/archguide.htm>>

This artifact is unexpectedly striking: covered in a reddish-purple lead glaze, it is studded with spots in which this glaze was worn down by exposure, creating silver-edged blue dots all over both sides, though they are larger and more numerous on the exterior. While it is clearly constructed of stoneware, often used in the seventeenth and eighteenth centuries for large vessels such as drinking mugs, this fragment's size and thickness immediately disqualify it for that usage: it measures 15.5 mm thick. Furthermore, by holding it to my eye and estimating the curvature, I was able to find an approximate interior diameter of 12 cm for the object of which this fragment was a part.

Based on its size, the most likely explanation for this artifact is that it was a part of a drainpipe, rather than any sort of tile or vessel. As seen in the complete segments of drainpipe which were excavated in Unit 8, drainpipes were constructed of two molded pieces, each forming a half-circle, before being fused together to create the tube shape required of a pipe. Thus, both the interior and the exterior could be glazed, a necessity to protect the pipe from excessive wear and to prevent the porous ceramic from merely absorbing fluid, a requirement that had been noted centuries before with drinking and eating vessels.<sup>171</sup> One of the most notable features about this fragment is the apparent size of the pipe from which it came. I estimated it to be about 12 cm in diameter, an unusually large size for a drainpipe.<sup>172</sup>

The property now known as the John Brown House was notoriously bad for drainage. Situated as it is on a hill, the proprietors would have had runoff at each rainfall, a common occurrence in Providence. John Brown himself had a great deal of experience with this issue. He wrote a letter to one young Edward Dexter, who proposed building his home adjacent to Brown's, advising him against such a course of action. This was in part because Brown wished Dexter to take his place in the international market, saying to him, "I want you to plant your Genneration in the Vicinity of waters ware (illegible)... you know I am old and worn in the service of Navigation. Will you take my place."<sup>173</sup> In the course of attempting to persuade Dexter, Brown introduces further reasons to build in another location by discussing the wet muddy land:

I assure you that the street too will ever be a whet muddey way, the natural Springs being such that cannot be got Clear of neither above nor below Ground. I have experienced a somewhat simenular Springey place tho not one Quarter so whet Viz. at the S. W. corner of my lot or Gardne below my House. Directly opposite Mrs. Spauldings I have a Drain from under the walls of my Celler that goes down by her house and a

---

<sup>171</sup> Deetz, p. 69.

<sup>172</sup> Ryzewski, Krysta. Personal communication. 11/30/09.

<sup>173</sup> Brown, John. Letter to Edw'd Dexter Sr. March 16<sup>th</sup>, 1796. Rhode Island Historical Society.

Drain on the upper side of the street below my Gardne wall Quite from the north of her Lott.<sup>174</sup>

Here we can see that this area of Providence, in addition to the frequent rains experienced by the city, had such a naturally high water table as to affect the surface of the land. If this quantity of water were flooding or endangering the safety of the Hale Ives house, where this fragment was found, an exceptionally large drainpipe might be required to remove some of the water from the land.

Another explanation is that the pipe was used for sewage. Sewage pipes are, by necessity, larger in diameter than water pipes. Marsden Perry added indoor plumbing to the John Brown House during his tenure there<sup>175</sup>; it is possible that the Gammells, who last owned the Hale Ives House, installed similar commodities. As most modern water pipes need to be only 1 inch in diameter to supply sufficient water to the house<sup>176</sup>, this pipe, at 4.72 inches in diameter, is excessively large even looking back a century. By contrast, a clay sewage pipe from a plantation in Georgia dating to the mid-1800s measures 2.25 inches in diameter<sup>177</sup>, a number much closer to the estimated diameter of this pipe.

This fragment of stoneware, part of a pipeline estimated at 12 cm in diameter, is likely either from a large drainage pipe to clear the soggy land of water or from a sewage line in the Hale Ives House. Without a manufacturer's mark or even an unbroken length of pipe, it is impossible to say for certain for what purpose this pipe might have been used.

---

<sup>174</sup> Ibid.

<sup>175</sup> Thelemaque, Alyssa. "History of the John Brown House." Presentation given 12/7/09.

<sup>176</sup> Carter, Tim. "Ask the Builder: Properly Size Your Water Lines." [http://www.askthebuilder.com/NH007 - Properly Size Your Water Lines.shtml](http://www.askthebuilder.com/NH007_-_Properly_Size_Your_Water_Lines.shtml) Viewed 12/12/09.

<sup>177</sup> "Sewer History: Pipe – Clay." <http://www.sewerhistory.org/grfx/components/pipe-cly1.htm> 2004. Viewed 12/12/09.

## Porcelain Plate | Bellarmine Sherd | Wire Nail with Star Design

Sarah Roberts

### Porcelain piece

This piece of porcelain was recovered from JBH 43. Though this context was Unit 8's most "recent" layer, or first context, by the end of excavating theories arose on how this context could actually be older than its elevation suggests. Since digging at Unit 8 culminated with the finding of gravel fill, we hypothesized that the contexts we had been digging in could have been filled from other areas of the yard. This piece of porcelain could perhaps confirm this theory, since it is from the late 1700s and therefore most likely not part of a modern context.



This porcelain piece was selected for its own object biography because it has a few different temporally diagnostic characteristics. Its substantial size, compared to other pieces found, allows for an analysis of its decoration and perhaps the chance to understand what it was once used for. In addition, the orange color around the rim stood out among the other pieces of porcelain found.

The dimensions of this artifact range from 4.0 to 7.2mm. By comparing the shape of the rim on the bottom to a diameter chart, it can be hypothesized that the diameter rim was about 5 inches. A dish of that proportion could have been a saucer, cup, mug, or child's plate. From studying the incline of the "bowl" shape, it was most likely a saucer of some sort. (Lab Reference Sheet)



The design on the piece shows a Chinese looking house or pagoda and a distinct border. This border is a distinct "blue spearhead border" that was produced from 1730 to 1780. Other examples of this border show scenes of houses and trees similar to the scene depicted on this piece. (Lab Reference Sheet, Identifying the 18<sup>th</sup> century) Creech describes, "Toward the middle of the century, the decoration became quite scenic, with 'Nanking' type patterns of pagoda and rocky riverscape scenes, often with bridges and birds. The complex scenes were



surrounded by complicated and *diapered* (with repetitive pattern) borders, often on octagonal notched-corner forms." He later explains Nanking was a popular dinnerware in the 1790s, which was marked by its "spearhead border." (Creech, 4)



Creech also explains that the orange color on the bottom rim confirms a similar time frame. He describes how, “Until about 1750, plates were also decorated on the back. The footrims of earlier 18<sup>th</sup> century plates, *sharply cut in a low V-form, usually turned orange in firing, from the presence of iron oxide in the kiln. The glaze became thicker, with the orange peel texture introduced c1765.*” (Creech, 4)

In this year’s and last year’s site reports there have been records of Canton porcelain found, but not Nanking. Tindall argues that “Canton was everybody’s porcelain,” so perhaps Nanking was a more unusual and exotic porcelain to have in the Americas. Creech explains that “(m)uch of the *Nanking* was gilded in England, making it quite desirable.” (Creech, 4)



Since this porcelain piece dates to approximately the time the John Brown House was built, perhaps this was a special dish that John Brown brought with him to his new home or some the acquired shortly after moving in. Since John Brown was a prominent trader and merchant there are many ways in which he could have acquired this piece.



Pictured here is an example of Canton ware from the Florida Museum of Natural History. This piece shows a border and scene similar to the Nanking ware, demonstrating that it is easy to confuse the two. “Canton’ ware was mass-produced at Canton after the American Revolution, as an export ware to America. It is sometimes referred to as “Ballast ware” for the low cost and huge amounts shipped (sometimes as ballast) of this porcelain.

‘Nanking’ ware is a more refined and higher quality export ware of the same period. It is distinguished from Canton Ware by it’s finer design execution, consistently cobalt blue paint, and its rim design, which consists of a geometric, diapered lattice rim decoration with occasionally detailed with overglaze gold.” (Florida Museum of Natural History) Therefore, we cannot be certain whether this piece is actually Canton or Nanking.

## Bellarmino Sherd

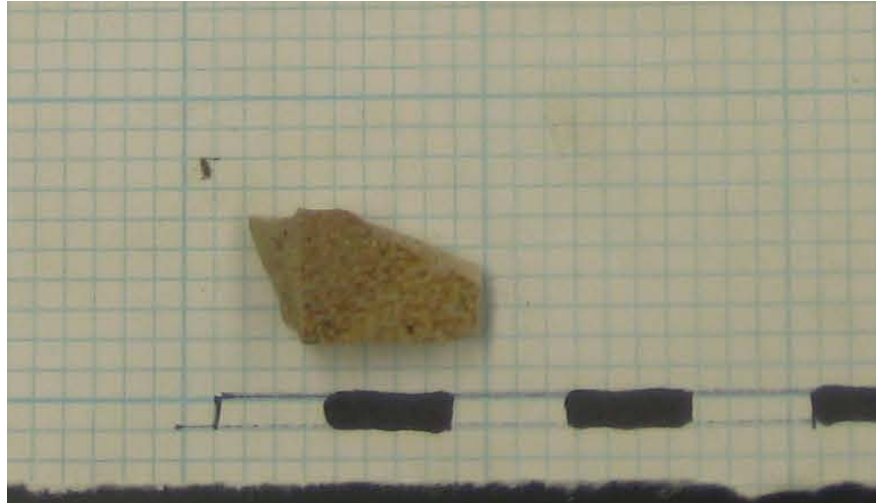

Though this piece of pottery is small, it is temporally diagnostic due to its unique material and glaze. This fragment is about 5.3 mm. It is made of grayish stoneware and covered with a orange/brown speckled glaze.

These characteristics are temporally diagnostic and date this piece anywhere from 1550 to



1725. This can be deduced from the knowledge that Bellarmino vessels, or “witch bottles,” were made of this gray stoneware and decorated with a orange salt glaze. They were a type of Rhenish stoneware manufactured in Frenchen. Often they are “ornamented with human or semi-human faces sprig-molded onto the neck, and generally have one or more armorial or pseudo-armorial medallions on the body.” (55, Hume) These bottles varied in size from 1 pint to 5 gallons. As we can see with this fragment they were “made from a gray-bodied stoneware coated with an iron-oxide slip that broke into a brown mottle when fired in a salt glaze kiln (thus earning the inaccurate title of tiger ware.” The bottles are also inaccurately known for having caricatures of the face of Cardinal Roberto

Bellarmino. (Hume, 55)

According to the Florida Museum of Natural History this type of brown Rhenish stoneware was mostly produced in Germany in the Rhine River valley. The term “Brown Cologne Stoneware” was used



“until the mid-16th century (after which most of this pottery appears on American sites), the nearby town of Frechen had replaced Cologne as a pottery center, and supplanted Raeren as the leading exporter of

brown stoneware” (Gaimster 1997). These jars are known as Bellarmine, Bartmanns, and greybeards because of the bearded male figures portrayed on the jar necks. “In general, the precision and quality of the applied molded elements declines through time, however a number of exceptions to this trend have been documented.” (Florida Museum of Natural History)

Since these bottles date hundreds of years before the John Brown House was built, John Brown or someone else who resided on this property must have collected these bottles and valued them as antiques. Since much pottery was found in Unit 8 and the other units near the house, we speculated that garbage was deposited right outside the kitchen against the house. We also speculated that most pottery pieces we found were used for domestic use and were not purely decorative. Knowing that this was brought over from Europe where it was considered a collectible, it may have served a decorative purpose at the John Brown House.

Other sources, however, write that these were latter produced in London and used in ale and for holding alcohol. Perhaps, then John could have used this trendy vessel to serve drinks at many parlor gatherings, known for their large consumption of alcohol. Additionally, these jugs are sometimes referred to as “witch bottles” and “it was believed that the witch bottle could counter the evil designs of a witch.” (Caiger) Knowing Brown family’s religious nature this could be a possibility, however, witchcraft was a more popular belief in the 17<sup>th</sup> century.

This temporally diagnostic piece also supports the hypotheses about JBH 43, the context in it was found. Unlike many other units, whose first context contained many modern artifacts, this context contains many objects that date as early as the 1700s. This piece of a bellarmine vessel dates as early 1550, making it the potentially oldest piece found in the context.



and up of the use and piece already purely jugs houses Brown his

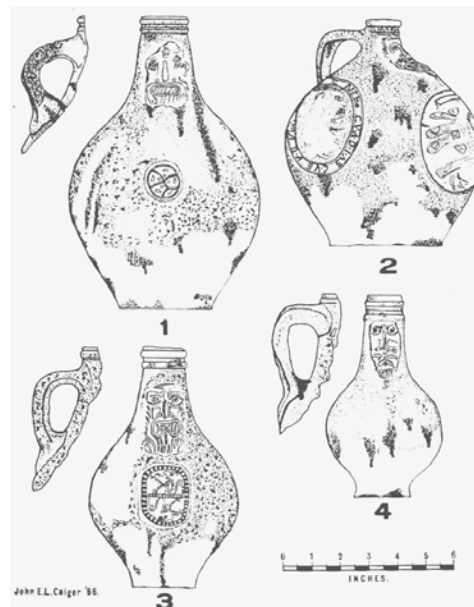

which

**Nail/screw with star design**



This nail was also found in JBH 43 and was chosen because of the distinct star design on the top of the head. The head's diameter is 7.6 mm and the body is 2.3 mm long.

In many context throughout this year and last, groups have found cut nails. Cut nails were first manufactured in the mid 1700s. Cut nails are sheared from steel plate that is the thickness of the shank and could be manufactured much faster than hand-forged nails. "As the process was mechanized, cost per nail was less. However, cut nail factories employed operators and attendants for each machine so the process was still labor-intensive. The noise in those mills was deafening as well." (Appalachian Blacksmiths Association) Cut nails were most popular 1820 to 1910, with the invention the wire nail.

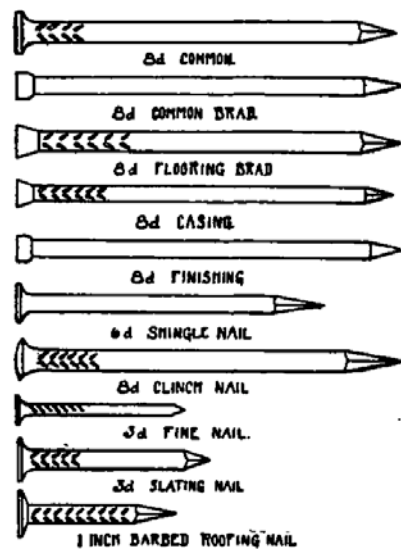

nail  
the  
of

Unlike cut nails, as shown here, wire nails are round. "Steel wire is fed into a machine that grips the wire, cuts it, makes the head, and chisels the point, all in one operation. This process is totally mechanized, requiring only someone to turn the machine on and off." (Appalachian Blacksmiths Association) Due to this new, more efficient process, wire nails replaced cut nails.

This nail is a wire nail which can be deduced by its round shape and the screw-like feature on the top of the body, which is also seen the wire nail diagrams. Therefore this nail can be dated from 1910 to today.



This object was chosen for a biography in hopes that it could be identified as temporally diagnostic due to its unique star design on the head. Unfortunately, no records of a manufacturer for such a design exist. In fact, it was difficult to find any records of nail produced with any designs at all. Simultaneously, the internet produces many results of acrylic finger nails when “nail” “design” and “star” are searched.

Though we can not be sure of the exact date of this nail past 1910, it can be speculated that this nail was used in a decorative piece of furniture and not in construction, due to its small size and decoration.

This piece does not fit in with the same time frame as the other object biographies from this context. Though, with our hypothesis that this context is actually fill from other parts of the yard, it could be speculated that this context is made up of very temporally different artifacts.



From the information we have learned about Marsden Perry, that he was a man of decadent and ostentatious taste, perhaps he would have appreciated the immense detail put into this nail. According to the presentation on Marsden Perry, “In the 1920’s, he undertook what apparently started as necessary repairs but soon ballooned into another round of renovations.” (Mittman) In would be consistent with both Perry’s appreciated of immense detail and extravagance, and his appreciation of new technology to use wire nails with such decoration.

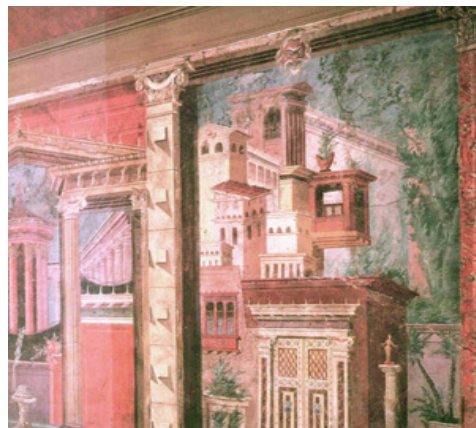

### Works Cited

Appalachian Blacksmiths Association

Archaeology Of College Hill 2008 Site Report

Caiger, John E. L., "Bellarmine Jugs." KAR Articles.

Creech, Millicent F., "Chinese Export Porcelain: Blue and White." At Home Magazine.

Florida Museum of Natural History Artifact Identification Guide

Hume, Ivor N. A Guide to Artifacts of Colonial America. Pennsylvania: University of Pennsylvania Press:  
1969.

Mittman, Final Presentation: Marsden Jaseal Perry: A Man of Excessive Taste

Tindall, Hiram. "The Canton Pattern of Chinese Export Porcelain." New York: Main Street/Universe  
Books, 1975.



## White-ware Sherd | Pipe Saddle | Pendant

Alexander Mittman

### White-ware Sherd with Green Transfer-Printing

As can be seen in the picture below, this is a sherd of “whiteware” ceramic, recognizable by its paper-white appearance where glazed.



The term is controversial among archaeologists as it is very difficult to distinguish the slight differences in the glazes of the major types of refined earthenware. Creamware, first invented by Josiah Wedgwood in 1750, is said to have a yellowish, creamy glaze, while pearlware is to be recognized by its bluish tint. The sherd here could be identified as whiteware, although what was referred to as creamware was approaching this same color by the 1820's.

What truly dates this sherd is its transfer-printed design, not its glaze nor its fabric. Color transfer-printing's origin is disputed. The Battersea factory, the Worcester factory and the firm of Sadler and Green in Liverpool all claim to have invented it some time around 1750. Soon after its invention, Wedgwood caught on and began making transfer-printed creamwares, sending them to be colored in Liverpool.<sup>xiv</sup> Many of the patterns from the early period of transfer-printing imitated Chinese porcelain designs and were almost always printed in blue to imitate the Chinese color scheme. It wasn't until the early nineteenth century that other colors and patterns became popular. By the middle of the nineteenth century, however, the transfer-printing industry entered a decadent phase in which multi-colored and complicated patterns seemed to explode out onto the new transferwares, covering every conceivable blank space with floral vignettes and complex landscapes.

This dates the current sherd under discussion most likely to sometime after the blue phase in the late eighteenth century and before the excess of the late Victorians in the latter half of the nineteenth century.

The sherd is clearly from a rim, and as such one might have a hard time figuring out what the main or central decoration was. Chinese-influenced wares often had rims with four-petaled semi-geometric patterns like the one featured on this sherd.<sup>xv</sup> Chinese-inspired pattern sets were produced in



Britain from 1783 until 1834, and “Orientalized” British scenes (or Chinoiserie) were produced from 1783 to 1873.<sup>xvi</sup> Repeating geometric patterns on rims in general (a more sure diagnostic feature) were produced primarily from 1784 until 1864.<sup>xvii</sup>

Transfer-printing, once again, may be used to date the sherd more specifically, though with a few small problems. Green transfer-printing was done on whitewares between 1829 and 1850, which seems to fit with our original hypothesis. However, Chinese-style transfer-prints on whitewares and pearlwares were more common before about 1815.<sup>xviii</sup> This seems to be a contradiction, but we can certainly imagine a throwback, or cheaper nostalgia piece being produced 15 to 35 years after the style had gone out of fashion. Another problem with dating this object is the fact that the rim seems to be unmolded (neither scalloped nor impressed), whereas scalloped rims with an impressed bud (shown below with green decoration) were put onto many bowls, plates, trays etc. produced between 1813 and 1834. Also, embossed (popular 1823-1835) or impressed rims (1841-1857) were both popular styles.<sup>xix</sup> Of course, that does not rule out the possibility of an unshaped rim, but it leaves a few questions anyway.



**Nine Gal Tavern/1995/L60.**

The original object could have been a cheaper model certainly, but why then was it printed in green which at the time was so trendy and popular? Could the whole thing have been a completely passe exercise, a way to use up a factory’s extra green ink and sell an underdecorated ware with an unshaped rim, an style which would have been both popular in the later half of the century and less pricy to manufacture? Or simply the common sort of anomaly?

## Pipe Saddle



This object was clearly factory-made. The fabric of the plastic where it is broken has waves in it from being poured into a mold and the intentional surfaces are perfectly smooth. This was perhaps the easiest object to identify, not as soon as it was first pulled out of the ground, but as soon as Google Patents could be accessed. As can be seen above, there is relief text in the plastic to the right of the ribs, reading:

1"x1/2"

100C

PAT #4789189

The patent number refers to something known as a "Pipe saddle" which is apparently used to prevent leakage at the junction of two pipes, via a barb seal inside the pipe.<sup>xx</sup> This is clearly a fragment of one and may have been discarded by a plumber or gardener after it had fractured and become useless. Or else, some sort of animal could have caused the damage after the saddle had been installed in the underground sprinkler system. The "100C" most likely refers to the maximum temperature the saddle can withstand while covering a pipe, but in that case it is unclear why the degree sign would be omitted in the embossment.

It was hard to determine what was meant by "1"x1/2'" as that set of measurements did not especially describe any dimensions of the pipe saddle fragment. This could be due to the fact that a large amount of it is missing. As can be seen on the patent diagrams, the barb seal is not actually attached to this piece of the saddle, but also, the factory-made model has a cross-piece along the brace that the patent does not include. This kind of discrepancy sometimes occurs between a given prototype or

original diagram and the final working product, especially when the piece is not the precise innovation itself (rather the barb seal is).

The fact of the embossed patent number at the bottom seems to establish a terminus post quem of 1988, the year that the patent was granted, as any models of this pipe saddle made before this date would not have been made on machines nor would they have a patent number embossed on them. However, the possibilities for contamination are troubling. If an animal such as a woodchuck were to have broken the original pipe saddle elsewhere on the property and buried the piece here in JBH43, 1988 becomes a completely arbitrary TPQ for the context. In fact, the unusual situation in Unit 8 could explain its deposition without serious problem. The possibility that the fill above the gravel feature which was covered by a tarp was backfill from other parts of the property or someplace nearby seems to explain its discovery in dirt that does not have a pipe system running through it.

### **Star Pendant**

This object is badly corroded, and likely made of brass. It is in the shape of a star pendant. Because of its small size (approx. 16 mm or 7/10 of an inch lengthwise), it was probably used as a “charm” on a bracelet.



This object brings up a few issues: first of all, who manufactured this utilitarian decoration and how can an archaeologist working contemporaneously (or relatively so) find the company, second, what caused the object to be disposed of, and lastly, how badly damaged was the object, before or after its deposition, until its excavation?

The corrosion certainly post-dates the deposition, as the owner would not have worn this outside their residence if it was so badly damaged. They would have thrown it out, since most of its decorative value has been destroyed by the damage (at least by contemporary standards). As it

wouldn't have left one's home and no one lives in the JBH anymore or disposes of their household trash in its yard, it may be safely assumed that it was an accidental or else an unplanned disposal.

There is also the question of how exactly then was the bottom damaged and when it was. As can be seen above, there are two nubs at the bottom of the object where clearly something has been broken off. If the object was damaged before its disposal, it could be that the owner threw it out immediately after its fracture while he or she happened to be in the yard for some other reason. The possibility that the bottom snapped on its own without its owner noticing and dropped onto the ground unseen is unlikely, as the pendant seems not to have been corroded or weakened in any discernable way before its deposition, though the bottom could have been the anchor point to the bracelet or necklace (and snapped by accident) and the top loop only decorative (the star would then be right-side-up when worn). Both of them at once could have been loops for the string of a bracelet to allow the charm to sit flush against the wrist. Without the whole object it is hard to tell.



The bottom piece (with a possible reconstruction above) must have become detached while it was in the ground, apparently from corrosive damage similar to that which has severely damaged the ring on the top. The question becomes then (if the bottom was almost as thick as the top and the top was not eaten away into nothing) why was the bottom not excavated from some location near the rest of the charm. The thickness of the bottom part was 3.4 mm before it branches off out where the missing piece was. If we were using a ¼" (6mm) mesh to sift, it could possibly have fallen through the mesh, though closer analysis of the angle of curvature and thickness of the possible bottom piece seems to discourage that hypothesis. The iterations of human error are of course infinite as well; it could have been swept out of the unit, overlooked, or not picked out of the sifter before the dirt was dumped out onto the backfill. Some sort of dislocation in the ground after deposition and corrosion is also a possibility.

To determine how great a possibility, some analysis of the corrosion itself also seems necessary. As the corroded dime, found in the context (dating to 2001) was not nearly as compromised as the charm (and dimes are primarily made of copper, which tarnishes in a similar way to brass)<sup>xxi</sup>, we can assume that the nickel in the dime prevented anything more than the tarnishing effect that typically affects copper (and is sometimes quite desirable for collectors). No dezincification (in which the zinc in the brass is separated from the alloy) appears to have occurred in the pendant, as there is no trademark red tint. This means that the zinc content of the pendant must be below at least 15%, whereas a higher zinc content is often used to prevent corrosion in brass.<sup>xxii</sup> General attack corrosion (tarnishing) seems to have covered most of the body and the joints and angles at the edges of the object seem to have succumbed to crevice corrosion which works faster and occurs when moisture pools in more vulnerable areas.<sup>xxiii</sup> The lack of aeration seems to preclude this much corrosion but oxidizing materials and other reactants could have been present in the soil. Galvanic corrosion could have caused the accelerated corrosion as well (in which the alloy acts like a battery because of a difference in the two metals' electrical resistance).<sup>xxiv</sup>

The bottom piece's disengagement could have also been caused by a common form of stress-corrosion cracking (specifically referred to as season cracking in brass) in which alloys with a higher copper content react with ammonia to form a cuprammonium ion which is water-soluble and dissolves out of the alloy.<sup>xxv</sup> Thus cracks begin to form in the metal and further stress from other corrosion could have caused the two pieces to disconnect.

As for the artifact's manufacturer, it is hard to ascertain. The variety of brass used in its manufacture is likely tombac (or rich low brass) which is around 15% zinc and is frequently used in decorative applications due to its ease of manipulation and low expense.<sup>xxvi, xxvii</sup> But, what the original piece may have looked like is anyone's guess. It could have been a charm bracelet, part of a necklace, a brooch or even a ring. The fact that we don't have even an entire piece of the original decorative object makes it hard to discern or even eliminate possibilities. We can only know for sure that it was not practical in its use because of its small size and unusual shape, but in the end, that isn't a very satisfying answer.

#### Works Cited

"Brass - Wikipedia, the free encyclopedia." 12/9/09 2009.

<[http://en.wikipedia.org/wiki/Brass#Brass\\_types](http://en.wikipedia.org/wiki/Brass#Brass_types)>.

"Brass corrosion." <<http://corrosion-doctors.org/MatSelect/corrbrass.htm>>.

Coysh, A. M., and K. Henrywood. The Dictionary of Blue and White Printed Pottery 1780 - 1880: Volume I. Suffolk, England: Antique Collector's Club, 1982.

"Diagnostic Artifacts in Maryland: Printed Underglaze Earthenware." 3/1/2009 2009.

<<http://www.jefpat.org/diagnostic/Post-Colonial%20Ceramics/Printed%20Earthenwares/Printed%20Earthenwares-main.htm>>.

"Dime (United States coin) - Wikipedia, the free encyclopedia." 12/1/2009 2009.

<[http://en.wikipedia.org/wiki/Dime\\_\(United\\_States\\_coin\)](http://en.wikipedia.org/wiki/Dime_(United_States_coin))>.

"Eight forms of corrosion." <<http://www.corrosion-doctors.org/Corrosion-History/Eight.htm>>.

"FLMNH - Historical Archaeology - Type Index Display (Pearlware, Transfer-Printed)."

<[http://www.flmnh.ufl.edu/histarch/gallery\\_types/type\\_index\\_display.asp?type\\_name=PEARLWARE.TRANSFERPRINTED](http://www.flmnh.ufl.edu/histarch/gallery_types/type_index_display.asp?type_name=PEARLWARE.TRANSFERPRINTED)>.

Lewis, Griselda. *A Collector's History of English Pottery*. Suffolk, England: Antique Collectors' Club, 1987.

Robertson, Duane D. Pipe Saddle. Patent 4789189. 12/6/1988.

"Season cracking - Wikipedia, the free encyclopedia." 10/19/2009 2009.

<[http://en.wikipedia.org/wiki/Season\\_cracking](http://en.wikipedia.org/wiki/Season_cracking)>.

Stelle, Lenville J. et al. "An Archaeological Guide to Historic Artifacts of the Upper Sangamon Basin, Central Illinois, U.S.A." 05/31/2007 2007.

<<http://virtual.parkland.edu/lstelle1/len/archguide/documents/archguide.htm>>.

"Tombac - Wikipedia, the free encyclopedia." 11/7/09 2009. <<http://en.wikipedia.org/wiki/Tombac>>.



## Canton Porcelain Fragment | Plastic Coffee Cup Lid Fragments | Angle Iron

Alyssa Thelemaque



My first object is a small fragment of porcelain that is known as Canton porcelain. Canton porcelain has some easily identifiable features (although in my opinion, easily mistaken for other types of Chinese porcelain ware), and Krysta pointed me in the direction of looking at Canton porcelain.

The production date range of Canton porcelain is 1790-1835. Canton porcelain is composed of a glassy vitreous paste. The color of the undecorated porcelain is white or grayish white and the thickness of Canton porcelain vessels is decidedly thicker than other porcelain types. Since the body of a porcelain artifact is almost impossible to examine unless the vessel is broken, Canton porcelain can also be identified by its glaze properties. The glaze of Canton porcelain is of poorer quality than that of other type and it possesses a slight “oatmeal” texture, that is to say a rippled surface texture, with occasional pinholes and inclusions. In terms of decoration, it is characterized by a grayish white background color with broad brush-stroked designs in shades of blue ranging in color from watery-gray blue to cobalt. The rim would have been decorated with blue lattice-type designs followed by wavy or scalloped lines. Common decorative motifs featured on the central medallion included pagodas, bridges and boats<sup>1</sup>. Like any porcelain, it would have been fired at temperatures of 1300-1450 degrees Celsius. Canton porcelain gets its name from both its decoration and design styles as well as where it was exported from. This type of porcelain was most likely manufactured and fired at the Province of Ching-Te Chen then sent to the port of Canton to be decorated and exported. Chinese Canton, and most other types of Chinese-manufactured porcelains, was known as “ballast ware” due to the way it was transported to America. Once in America, the Canton sets would have usually found their way to the merchant class—who followed the example of George Washington who favored Canton sets for dinner<sup>1</sup>.

This particular fragment is quite small—the bottom is  $2\frac{3}{4}$  cm, the slanted side is  $1\frac{1}{2}$  cm, the top is  $1\frac{3}{4}$  cm, and the straight side is  $1\frac{1}{4}$  cm. Overall, it has a thickness that increases from 1mm to 2.5mm. The porcelain is decorated with varying shades of blue. The outer edge is painted with what is simply a decorative pattern while it turns into what would have been part of an actual image or motif as



it moves towards what would have been the center of the intact object. While Canton porcelain commonly took the form of a bowl, plate, or platter, this particular fragment is too small to be able to ascertain a diameter that would indicate what type of vessel of which it would have been a part. The brown inclusion is indicative of the slightly poorer quality crafting and glazing that typified Canton porcelain.

This object was found in JBH 57 of Unit 8. Other finds in the unit consisted of creamware (1760-1820), pearlware (1780-1840), whiteware (1820-present), chinese porcelain with a gold rim, other porcelain fragments, European soft paste porcelain (1745-1800), brown colored lead glaze redware (1725-present), large red ceramic drain pipes, 1946 wheat penny, duct tape, and a Twix candy wrapper. The surrounding contexts also featured types of porcelain, but there were some finds, such as a coffee lid in the context above it and a canvas tarp in the context below it, that make it difficult to figure out the context in which the object would have been deposited<sup>1</sup>.

The huge range of dates between the objects found in JBH 57 and also the fact that contemporary items (the canvas tarp) was found below this Canton porcelain shard makes it difficult to determine how or why this article got deposited. The fact that this was obviously deposited with a random variety of objects evidences some sort of dumping situation.

I'm going to assume that Unit 8 was the location for a variety of "dumps." It's very close in proximity to the 3-story addition made by Elizabeth Amory Ives Gammell in the 1850s and the interior changes to the dining room made by Marsden Perry in the early 1900s<sup>1</sup>. I think one explanation for this wide variety of objects (including this Canton porcelain shard) is that when the house was being built upon, this particular location was used as a dumping ground when the extensive architectural changes were being made close nearby. It's also possible that when the Rhode Island Historical Society took possession of the home in 1942 and made renovations, that the area was used for a dumping site. Regardless of when, I think that the most credible explanation for how this particular object got into Unit 8 is that it was dumped along with a variety of other objects during some sort of architectural update to the home.



My 2<sup>nd</sup> object biography is focused on 3 plastic fragments that came from the same object. An avid coffee drinker myself, it was fairly easy to tell that these plastic fragments came from a plastic coffee cup lid. The 3 fragments had fairly similar dimensions. There is a thin curved piece that measure about 2 ½ cm across. There is a wider curved piece with 3 indentations in it, and that fragment also measures 2 ½ cm long. The third fragment is wider and has a sort of tab like protrusion from the center; this fragment measures 2 ¼ cm across. Because of their coloring and construction, it is also safe to assume that the fragments all belonged to the same object.

Although it was fairly obvious that the fragments were once part of a coffee cup lid, the problem with these fragments arises in dating. Although plastic coffee cup lids haven't been around for hundreds of years, it was still difficult to provide some sort of date for these fragments. After a brief look at the excavation report from 2008, I saw that this lid wasn't like the McDonald's lid that had been found in Unit 1<sup>1</sup>. After ruling out that I would be able to date the cup in terms of the history of the company by which it was produced, I had to think of a different way to find a date for the fragments. I wasn't lucky enough to find some sort of brand name, patent number, or other immediately identifiable characteristics, so I decided to take a look at coffee cup lid patents and see if I could find a type that seemed to match my fragments.

The distinguishing features of this particular lid are in the various indentations and ridges in the design feature. Generally, coffee cup lids patented after 2000 are fairly smooth in terms of their design<sup>1</sup>. The only indentations of these types are in the form of the holes used for drinking, but the lids themselves are fairly simple (think Starbucks coffee cup lids). The earliest plastic coffee cup lid that was specifically marketed for its resealable "on-the-go" characteristics was from 1984<sup>1</sup>, but the structure of that type of lid was much bulkier than that of the fragments I found. It was in looking at the patents for coffee cup lids introduced between 1997<sup>1</sup> and 2000 that I found a lot of coffee cup lid types that looked similar in structure to the ones I found.

I would like to say that this particular coffee cup lid is of the variety that was introduced between 1997 and 2000. In looking at various patent images for coffee cup lids introduced around the time, those lids had the same types of decorative indentations and raised areas that I saw on these fragments. Although the Sherri Cup Company introduced their first to-go coffee cup in 1963<sup>1</sup>, I don't think that this type of lid can be dated that far back. Its characteristic indentations and raised tab-like feature really seem to fit with the lids introduced between 1997 and 2000. While this doesn't necessarily mean that the fragments were deposited within that time frame, it does mean that the earliest the coffee cup fragments were deposited was 1997.

The next question is how did the coffee cup lid fragments get there? At first, one might want to say that somebody was walking by after having finished drinking their coffee, and they dropped the fragments on the ground. But the object's deposition has to be examined in context with the other objects it was found with. These fragments were found in Context 46 of Unit 6. The other items found in JBH 46 consisted of a wire nail (1877-present), glass shards, fragments of a measuring cup, plastic beads, a piece of brown rubber, whiteware (1830s-present), creamware shards (1762-1820), brick fragments, shell pieces, and a plastic soda bottle cap gasket<sup>1</sup>.

Like the Canton porcelain shard, it's hard to find an explanation for how this object was deposited when it is found underneath objects that are significantly older. Attributing its deposit to another "dumping ground" scenario would account for the wide range of dates that the objects in the context possessed.

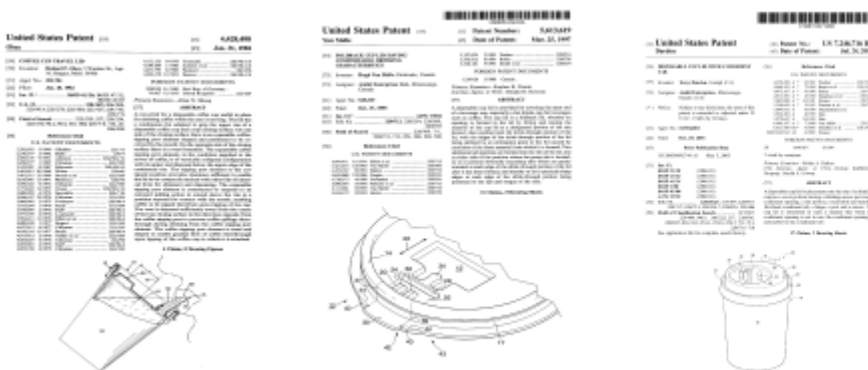

**Figure 1: US Patent No. 5613619. Issued March 25, 1997.**

**Figure 2: US Patent No. 4428498. Issued January 31, 1984**

**Figure 3: Coffee Cup Lid US Patent No. 7246716. Issued July 24, 2007.**



This third object was found in Context JBH 61 of Unit 6. It is a piece of heavily rusted iron that measures  $11 \frac{3}{4}$  cm across,  $4 \frac{3}{4}$  cm long, and 4.5mm thick. Because it has neatly perforated holes, smooth edges and a hefty weight, this iron object was probably used for architectural purposes. Because of the sharp 90 degree angle and carefully placed holes, it also seems that this object was used as an angle iron or something to anchor some sort of larger feature<sup>1</sup>.

Although there were some inconsistencies (plastic report cover sliding bar), the other finds in the unit were consistent with objects that would have been utilized in domestic architecture: mortar, bricks, red tiles, other flat iron pieces, cut nails, and a slab of marble. After being able to safely believe that this was an architectural object, the next task was to find a date for the object. This task proved to be extremely difficult. The thick layer of rust covered the entire surface, and if there were any identifying features on the object such as a maker's mark, it is impossible to see underneath the rust. Modern angle irons are fairly thin, so that was my first indication that this particular angle iron is relatively old.

Since the main thing to notice about this object is the rust, I decided to use that to help me date the object. Rust is a form of corrosion that affects metals like iron and steel when they are exposed to air and moisture. Since rusting can happen fairly quickly (a matter of days), I wasn't able to say that the object was x amount of years old because y amount of rust was present. But, I was able to take the very presence of the rust as something to date.

Today, metal objects—specifically irons and steels—are treated in order to prevent them from rusting, especially if they are going to be used for something like supporting an architectural structure. Galvanization is a method that protects iron from rusting by completely coating the surface with a hot layer of zinc. Galvanization was introduced in the 1830s, and was officially patented by Stanislaus Sorel, a Parisian civil engineer, on May 10, 1837<sup>1</sup>. It wasn't until after that date that public and domestic architecture began to take advantage of the anti-rusting properties of galvanization.

The anti-rust protection offered by this method can last for decades. While rusting is inevitable, even on objects protected by galvanization, this is only in objects directly exposed to lots of water and sunlight. If this object was indeed an angle iron, it is most likely that it was used to anchor something to the ground. It would have been positioned between the ground and whatever object it was holding to the ground. If that were the case, there wouldn't have been whole sides of the object exposed to the natural elements.

I think there are two plausible explanations for the appearance of rust on this angle iron. First, that the heavy amounts of rust covering every part of the object's surface indicate that the object simply sat out in the open air exposed to oxygen or moisture. Or secondly, that the angle iron was indeed partially hidden from the elements, but it had not been treated by galvanization. A lack of galvanization would account for the heavy amounts of rust and corrosion.

In terms of use, if the second explanation is taken to be true, then that would indicate that this object was dated before 1837. If the object is dated to pre-1837, that would mean that the angle iron came from a structure that had been constructed before that date. Knowing the history of the John Brown House landscape, the only architectural changes to the house before 1837 consisted of the construction of the various outhouses that existed in the yard of the property. So it's possible that this angle iron was never galvanized and therefore used originally used in one of the outhouses constructed on the property before 1803. Another explanation for when this object was used is that the angle iron was used in the construction of the Robert Hale Ives house around 1857 and he simply didn't use metal objects that had been galvanized.

In terms of deposition, if the object was used in one of John Brown's outhouses, than it could have been deposited in the ground when the outhouses were destroyed around 1857 for the construction of the Hale Ives house. If the angle iron was used in the construction of the Hale Ives House, than it's possible that the object was deposited between 1923 and 1925 when Marsden Perry razed the Hale Ives House.

The introduction of the concept of galvanization produces a variety of explanations as to the original use of this iron object and when it was deposited.

### **Object Bio Bibliographies**

Allen, Lorena Overstreet. "Chinese Canton Porcelain." *Antiques and Art Around Florida*. 3 Dec 2009. <http://aarf.com/fecant98.htm>

"Canton Porcelain." *FLMNH.ufl.edu*. Florida Museum of Natural History, Web. 2 Dec 2009. <[http://www.flmnh.ufl.edu/histarch/gallery\\_types/type\\_index\\_display.asp?type\\_name=PORCELAIN,%20CANTON](http://www.flmnh.ufl.edu/histarch/gallery_types/type_index_display.asp?type_name=PORCELAIN,%20CANTON)>.

"History of Galvanization." *gaa.com*. Galvanizers Association of Australia, Web. 12 Dec 2009.  
<[http://www.gaa.com.au/benefits\\_of\\_galvanizing/benefits\\_h.html](http://www.gaa.com.au/benefits_of_galvanizing/benefits_h.html)>.

"The Cup That Launches a Thousand Ships." *NewYorkFirst.com*. The New York First Company,  
Web. 12 Dec 2009. <<http://www.newyorkfirst.com/gifts/7073.html>>.

Untitled. *John Brown House Binder #4 JBH General Information and Description; Room by  
Room*, John Brown House Museum.

"US Patent No. 5361639." *Patent Storm*. Patent Storm Patent Index, Web. 10 Dec 2009.

"US Patent No. 4428498." *Patent Storm*. Patent Storm Patent Index, Web. 10 Dec 2009.

"US Patent No. 7246716." *Patent Storm*. Patent Storm Patent Index, Web. 10 Dec 2009.

## Gimlet Point Screw } Polychrome Overglaze Chinese Porcelain | Anthracite Coal

Michael Camarillo

### Gimlet Point Screw



The above screw was found in JBH 47, a natural stratigraphic context level in Unit 9. Instantly, an intuitive reflection would illuminate the connections between the use of screws in building projects and the close proximity to the house—in addition to providing an impetus for further excavation as we were searching for possible outbuildings. The screw was greatly covered by iron-oxide corrosion and since this process is caused by the introduction of liquid to the metal surface, it is in agreement with John Brown’s account in his letter to Edward Dexter Sr. about the land being a “muddey place”.<sup>178</sup> Amidst the lumps of corrosion near the head of the screw, the artifact is easily distinguishable. It measures 47.8 mm long, which doesn’t seem to be altered by breakage as the tip appears to be intact, 5.0 mm wide on the lower shaft, and the head is 8.5 mm wide. Although it is impossible to decipher whether the screw has a crosshatch in the head or otherwise without the use of advanced corrosion-removal methods, we can note the rounded shape of the head. Screws with this type of head are often used as machine screws, which would not have been the case during the early years of the John Brown House, thus extending the range of possible dates.<sup>179</sup>

The preceding point disagrees with the implications founded by examining the shaft and threads. Early colonial screws, dating from the mid-18<sup>th</sup> century to the mid-19<sup>th</sup> century, were more often a product of hand-made practices. This created a crudely cut screw with threads of rather high pitch (their width in relation to the body of the shaft). The artifact from JBH 47, although laying claim to threads that appear regular and refined, consists of a high thread pitch that indicates a shaft of thin

---

<sup>178</sup> Archaeology of College Hill: References & Resources. *John Brown Letter*. 16 March 1796. December 14, 2009 <<http://proteus.brown.edu/archaeologyofcollegehill/6499>>

<sup>179</sup> Encyclopedia Britannica: Online. *Screw*. Singh, Shiveta. 26 November 2008. December 15, 2009 <<http://www.britannica.com/EBchecked/topic/529876/screw>>



proportions, suggesting an earlier date than the ‘machine-screw’ hypothesis might suggest.<sup>180</sup> The V-thread, a common indicator of hand-made screws, is clearly apparent on this screw. The constant recurrence of building projects on the John Brown House lot—1786-1854 Brown Family, 1854-1901 Robert Hale Ives, 1901 Marsden Perry—gives rise to a wide sense of ambiguity for the dating of such architectural artifacts as the screw.<sup>181</sup>

Clearly the screw can be dated well into the late-20<sup>th</sup> century due to its resemblance to a machine screw; therefore, the focus must be centered on finding the earliest possible date of its manufacturing range. I pointed out the high pitch of the thread as a reason to believe that the screw is hand-made; however, the tight wrap (2.3 mm separating the crests of eat thread) and the regularity of grooves overwhelmingly supports a machine-made screw. Instantly, we could date the screw to 1760 as the year marked the first use of a lathe for making screws. It is important, however, to compare this screw to those during the early years of lathe production. The picture embodies the crudeness of a screw forged around 1795.

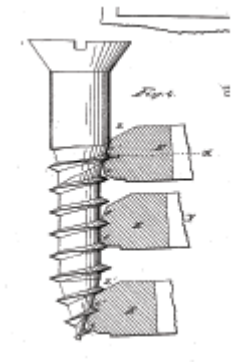

observable is the common practice of producing very short screws and continuous tapering threads, which resulted in a screw that did not securely engage the wood.<sup>182</sup> Furthermore, screws produced by early manufacturing are identifiable by longitudinal scratches that remain from the wire-forming process—an attribute that is absent in later screws (and this artifact) due to higher operating speeds of threading tools. The most notable event which caused the dating of this artifact was the development of a gimlet point. The gimlet point is a tapered (threaded) cone point which often has an angle of 45-50

degrees. This promotes the inseting and hold of the screw, fixing the problem of earlier screws. This point was imitated in early production but often through continuous tapering of the threads, as seen on the 1795 screw. Instead, this innovation suddenly increases the angle of taper at the point. Sloat and Springsteen filed for U.S. Patent 154 upon their invention of the threaded cone in 1837, thus giving us the earliest date to which the JBH 47 screw can be manufactured; however, the first screws to be

<sup>180</sup> Chapter II: *The Development of the Lathe Since the Introduction of Screw Threads*. 21 February 2009. December 15, 2009. <<http://chestofbooks.com/home-improvement/woodworking/Lathe-Operation/Chapter-II-The-Development-Of-The-Lathe-Since-The-Introduct.html>>

<sup>181</sup> Wikipedia: The Free Encyclopedia. *John Brown House*. 7 November 2009. December 15, 2009. <[http://en.wikipedia.org/wiki/John\\_Brown\\_House\\_\(Providence,\\_Rhode\\_Island\)](http://en.wikipedia.org/wiki/John_Brown_House_(Providence,_Rhode_Island))>

<sup>182</sup> White, Christopher. *Observations on the Development of Wood Screws in North America*. Museum of Fine Arts: Boston. 2005

manufactured with this gimlet point date to 1849 by Cullen Whipple at the New England Screw Company.<sup>183</sup>

The JBH 47 screw, which dates 1849-present, is importantly found in close proximity to the house's addition that was added by Marsden Perry, together in close association with cut nails. This suggests that the screw could have been used in the building of said addition, or that of underlying outbuildings. As noted in the Excavation Summary, the preceding context (JBH 44) consisted of many non-diagnostic fragments of hand-cut wood, slabs of slate, and pieces of red-clay brick; and the following context (JBH 53) produced a screw, a handful of cut nails, and a cut iron stake. This conglomeration of evidence implies the presence of a building project at some point in this area's history. JBH 47, as a uniform context, can not be dated within the early range of the screw as JBH 53 consists of objects that are manufactured as late as 1993. The installation of the sprinkler and electrical systems must have caused disturbance to the underlying context, resulting in backfill and the random dispersal of objects from various date ranges.

---

### Polychrome Overglaze Chinese Porcelain

The prevalence of trade throughout the early years of John Brown House best suggest the presence of internationally-imported artifacts, notably ceramics and porcelain which indicated a sense of societal status, a concept intricately intertwined with the various owners of the plot. Brown was greatly associated with the international trade of Nicholas Brown & Co. upon the advent of the 19<sup>th</sup> century.<sup>184</sup> Much of the trade included the Orient, notably the East India Trading Company. A century later, Marsden Perry, a man of high income who eccentrically attempted to be accepted into the elite society of the Providence wealthy, acquired and filled his collections with priceless objects such as Chinese porcelains.<sup>185</sup> These historical events importantly define the significance of the porcelain sherd found in JBH 47.

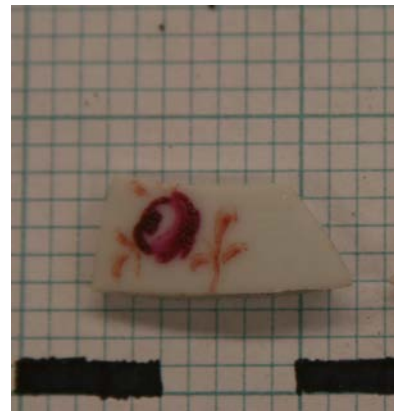

the  
John

---

<sup>183</sup> White, Christopher. *Observations on the Development of Wood Screws in North America*. Museum of Fine Arts: Boston. 2005

<sup>184</sup> Archaeology of College Hill: References & Resources. *The Providence Sunday Journal*. 13 October 1901. December 14, 2009 <<http://proteus.brown.edu/archaeologyofcollegehill/6499>>

<sup>185</sup> Find A Grave. *Marsden Perry: Grave Memorial #9072786*. Swan Point Cemetery: Providence. 9 July 2004. December 15, 2009 <<http://www.findagrave.com/cgi-bin/fg.cgi?page=gr&GRid=9072786>>

The artifact is pearl white in color with a crimson and gold overglaze design—an effort of intensifying the decoration on the vessel.<sup>186</sup> Unlike most hand-painted porcelain imported into the colonies, this sherd does not have a blue underglaze or overglaze. However, similar methods used to produce the floral motifs in “Chinese Imari” porcelain overglaze decoration are present in this case.<sup>187</sup> Thus, this artifact—measuring 15.9 mm on the short side, 23.4 mm on the long side, 10 mm tall, and 2.7 mm wide—is Chinese in make. As aforementioned, the decoration on the face of the sherd is emblematic of a floral design, although it is rather unrefined in comparison to some vessels. The central rosette is finished in a crimson color, bordered by gold accents which bear resemblance to leaves or vines. The visible brush strokes are evidential of hand-painted rather than a transfer-print—a practice which takes a prefabricated image and prints it on the ware. The lack of intricate detail in the design could be due to a period of mass production and exportation from its manufacturing location; such occurrences can be dated to the mid-late 18<sup>th</sup> century between the chief Chinese port, Canton, and the European-market, in turn, that the American-market, as well.<sup>188</sup> Much of Europe’s wealth during the 17<sup>th</sup> and 18<sup>th</sup> centuries was a direct result of sea-borne commerce and trade. Since Europe, notably Great Britain, had a thriving trade exchange with China and America, they acted as an intermediary in much of the porcelain trade. This presented opportunities for wide dispersal of Chinese porcelains, not simply exclusive to the most prominent citizens; this further supports the dating of this artifact sometime during the 18<sup>th</sup> Dynasty.

It is difficult to find a suitable category that this sherd fits with; however, it is suggestive of the common mid-18<sup>th</sup> century development of *famille rose* porcelains, which were made primarily for export in the Western-market rather than domestic use in China. In addition, the patterns bear similarities to later motifs of the 19<sup>th</sup> century such as the Rose Medallion and Mandarin porcelains. Since these patterns were derived from the figural designs of the *famille rose* porcelains, we can more accurately date the artifact to the 18<sup>th</sup> century.<sup>189</sup> The Florida Museum of Natural History presents a fitting typology for the artifact, categorized as Ching Dynasty Polychrome Overglaze porcelain dating between



<sup>186</sup> Gordon, Elinor. *Chinese Export Porcelain: An Historical Survey*. Main Street/Universe Books: New York. 1975. pg. 32

<sup>187</sup> Historical Archaeology at the Florida Museum of Natural History. *Chinese Export Porcelain, Ching Dynasty Polychrome Overglaze*. Florida Museum of Natural History: Gainesville. 1995. <[http://www.flmnh.ufl.edu/histarch/gallery\\_types/type\\_index.asp?type\\_name=POLYCHROME%20OVERGLAZE](http://www.flmnh.ufl.edu/histarch/gallery_types/type_index.asp?type_name=POLYCHROME%20OVERGLAZE)>

<sup>188</sup> Gordon, Elinor. *Chinese Export Porcelain: An Historical Survey*. Main Street/Universe Books: New York. 1975. pg. 23-24

<sup>189</sup> Gordon, Elinor. *Chinese Export Porcelain: An Historical Survey*. Main Street/Universe Books: New York. 1975. pg. 165-66

1700 and 1750. This agrees with the previously stated, historically based conjecture. The defining attributes describe specimens of this category as being white, thin, highly vitreous paste that is smooth and translucent—closely comparative to the description of our artifact.<sup>190</sup>

As noted, this porcelain sherd was the product of JBH 47 in Unit 9. This context consisted of many inclusions; however, only two other artifacts were pottery sherds—a piece of plain creamware (1762-1820) and a Ching Dynasty Blue on White porcelain (1644-1912). Considering the three artifacts together with the high abundance of anthracite coal and the proximity to the addition of the house that held the kitchen, suggests a common use as kitchenware followed by the possible discarding of broken vessels. Notice the much wider date range of the blue on white porcelain; the widespread use of such wares did not occur for the polychrome overglaze porcelain. This could help to localize the context to a short, specific time span. However, numerous artifacts were found in the following context, JBH 53, that are more recently dated. The common theme of soil backfill and modern disturbance may be the cause of such circumstances. In addition, the concept of time lag, in which ceramic artifacts have lifespans of as much as 15 years and more beyond their manufacturing ranges, notes the possibility of the artifact being used well beyond 1750, thus fitting into the range of the context.<sup>191</sup>

---

### **Anthracite Coal**



Anthracite coal was a common visitor in every context my group excavation in STP 3 and Unit 9. The fragments varied in size and abundance; however, their consistent presence provided each context with an easily diagnostic artifact. The above pieces, a part of JBH 60 from STP 3, are the largest specimens of this organic mineral, each measuring at least 1 cm wide with the largest (the piece in the bottom left corner) claiming a width of 2 ½ cm. Although these artifacts are small and not as

---

<sup>190</sup> Historical Archaeology at the Florida Museum of Natural History. *Porcelain, Ching Polychrome Overglaze*. Florida Museum of Natural History: Gainesville. 1995. <  
[http://www.flmnh.ufl.edu/histarch/gallery\\_types/type\\_index\\_display.asp?type\\_name=PORCELAIN,%20CH%20ING%20POLYCHROME%20OVERGLAZE](http://www.flmnh.ufl.edu/histarch/gallery_types/type_index_display.asp?type_name=PORCELAIN,%20CH%20ING%20POLYCHROME%20OVERGLAZE)>

<sup>191</sup> Adams, William H. *Dating Historical Sites: The Importance of Understanding Time Lag in the Acquisition, Curation, Use, and Disposal of Artifacts*. *Historical Archaeology* 37(2). 34-64. pg. 34

aesthetically pleasing as porcelain sherds, anthracite is an extremely significant artifact that suggest the early wealth of the John Brown family and multiple possibilities of use by Marsden Perry and, now, the Rhode Island Historical Society.

Emblematic of the picturesque anthracite fragments found in numerous resources, these fragments are dark black, consist of sharp cleavage, and exhibit a high luster. They are debased by the mud and grime which clings on to the edges; however, this is due to relatively futile cleaning methods with a toothbrush. Further cleaning is required for the fragments to match their initial appearance. Also referred to as black coal, hard coal, and stone coal, anthracite has the highest carbon count and fewest impurities of any type of carbon.<sup>192</sup> Anthracite is widely used as a fuel for producing heat; therefore, the fragmented chunks may be how they appeared during their use by the JBH-owning families, as small fragments burn at a quicker rate than whole pieces.

Coal seams were first discovered by Connecticut settlers in 1762, with the first use of anthracite being dated around 1768. Mining capabilities did not develop to a mode of production for nearly another decade; therefore, no indication of its use is available until 1788, when the first industrial use for heating and drawing iron for making nails was recorded.<sup>193</sup> We cannot accurately date the fragments from JBH 60 to 1788, although conjecture might argue such a statement due to the use for heating, as the sources of coal were a significant distance from Providence and cross-country travel was not a common occurrence and definitely not the most ideal. At this time John Brown had just laid down the large investment of constructing the house on Benefit Street, thus the expenditure of retrieving a fuel source of such a low calorific value can be deemed unnecessary. The revolution of industrial development and growth that began in “The Coal Region” of Northeastern Pennsylvania, most likely reached the eastern seaboard after the 1790 discovery on the Schuylkill River and the experimental use in residential heating in 1808.<sup>194</sup> Due to the Brown’s prominence and wealth, it would not be a stretch to suggest that they owned an iron furnace for use of anthracite residential heating. Although we can now date the anthracite fragments from 1790-present, it seems more likely that the artifacts are a result of the ownership of Marsden Perry. Throughout the 19<sup>th</sup> century, anthracite use was relatively young and underdeveloped, with the first mining company not being established until 1820. The turn-of-the-century witnessed the steep incline following the 1890 strike; employment reached a maximum of 180,000 workers in 1914 and production peaked over 100 million tons in 1917.<sup>195</sup>



<sup>192</sup> Wikipedia. *Free Encyclopedia. Anthracite Coal*. 15 December 2009. December 15, 2009. <  
[http://en.wikipedia.org/wiki/Anthracite\\_coal](http://en.wikipedia.org/wiki/Anthracite_coal)>

<sup>193</sup> District 1. *Coal Mine Safety and Health. History of Anthracite Coal Mining: Time Line*. United States Department of Labor, Arlington. December 15, 2009. <[http://www.msha.gov/District/Dist\\_01/History/history.htm](http://www.msha.gov/District/Dist_01/History/history.htm)>

<sup>194</sup> Black Diamonds Experience Pennsylvania’s Anthracite Mining Heritage. *History*. Schuyl, Inc. <  
<http://www.blackdiamonds.com/history.html>>

<sup>195</sup> District 1. *Coal Mine Safety and Health. History of Anthracite Coal Mining: Time Line*. United States Department of Labor, Arlington. December 15, 2009. <[http://www.msha.gov/District/Dist\\_01/History/history.htm](http://www.msha.gov/District/Dist_01/History/history.htm)>

As aforementioned, the presence of anthracite was a recurring theme in all five contexts of Unit 9 and STP 3. Once again, the close proximity to the house might suggest this high prevalence—as it could be assumed that furnaces were present in the kitchen and rear of the house. Although this point is unsubstantiated by relevant evidence, modern uses of anthracite for purposes such as electrical steam-generated power and landscaping should be considered.<sup>196</sup> Especially in the case of STP 3 and its location near a walkway for a National Museum, the artifacts from JBH 60 could be resulting pieces from the movement of larger fragments of landscaping anthracite.

---

<sup>196</sup> AnthraciteCoal.com, Inc. *Landscaping*. December 15, 2009. < <http://www.anthracitecoal.com/welcome.htm> >

## **Works Cited**

Adams, William H. *Dating Historical Sites: The Importance of Understanding Time Lag in the Acquisition, Curation, Use, and Disposal of Artifacts*. *Historical Archaeology* 37(2). 34-64.

AnthraciteCoal.com, Inc. *Landscaping*. December 15, 2009. <  
<http://www.anthracitecoal.com/welcome.htm>>

Archaeology of College Hill: References & Resources. *John Brown Letter*. 16 March 1796. December 14, 2009 <<http://proteus.brown.edu/archaeologyofcollegehill/6499>>

Archaeology of College Hill: References & Resources. *The Providence Sunday Journal*. 13 October 1901. December 14, 2009 <<http://proteus.brown.edu/archaeologyofcollegehill/6499>>

Black Diamonds: Experience Pennsylvania's Anthracite Mining Heritage. *History*. Schuyl, Inc. <  
<http://www.pacoalhistory.com/history.html>>

*Chapter II: The Development of the Lathe Since the Introduction of Screw Threads*. 21 February 2009. December 15, 2009. <<http://chestofbooks.com/home-improvement/woodworking/Lathe-Operation/Chapter-II-The-Development-Of-The-Lathe-Since-The-Introduct.html>>

District 1- Coal Mine Safety and Health. *History of Anthracite Coal Mining: Time Line*. United States Department of Labor: Arlington. December 15, 2009 <  
[http://www.msha.gov/District/Dist\\_01/History/history.htm](http://www.msha.gov/District/Dist_01/History/history.htm)>

Encyclopedia Britannica: Online. *Screw*. Singh, Shiveta. 26 November 2008. December 15, 2009 <<http://www.britannica.com/EBchecked/topic/529876/screw>>

Find A Grave. *Marsden Perry: Grave Memorial #9072786*. Swan Point Cemetery: Providence. 9 July 2004. December 15, 2009 <<http://www.findagrave.com/cgi-bin/fg.cgi?page=gr&GRid=9072786>>

Gordon, Elinor. *Chinese Export Porcelain: An Historical Survey*. Main Street/Universe Books: New York. 1975. pg. 165-66



Historical Archaeology at the Florida Museum of Natural History. *Porcelain, Ching Polychrome Overglaze*. Florida Museum of Natural History: Gainesville. 1995. <  
[http://www.flmnh.ufl.edu/histarch/gallery\\_types/type\\_index\\_display.asp?type\\_name=PORCELAIN,%20CH%20ING%20POLYCHROME%20OVERGLAZE](http://www.flmnh.ufl.edu/histarch/gallery_types/type_index_display.asp?type_name=PORCELAIN,%20CH%20ING%20POLYCHROME%20OVERGLAZE)>

White, Christopher. *Observations on the Development of Wood Screws in North America*. Museum of Fine Arts: Boston. 2005

Wikipedia: The Free Encyclopedia. *Anthracite Coal*. 15 December 2009. December 15, 2009. <  
[http://en.wikipedia.org/wiki/Anthracite\\_coal](http://en.wikipedia.org/wiki/Anthracite_coal)>

Wikipedia: The Free Encyclopedia. *John Brown House*. 7 November 2009. December 15, 2009.  
<[http://en.wikipedia.org/wiki/John\\_Brown\\_House\\_\(Providence,\\_Rhode\\_Island\)](http://en.wikipedia.org/wiki/John_Brown_House_(Providence,_Rhode_Island))>

## Assorted Canton Porcelain Pieces | Brown Lead-Glazed Redware | Terra Cotta Drainpipe Segment

Andrew Seiden

### Assorted Canton Porcelain Pieces (Unit 8 JBH 49)



These porcelain fragments were found in context JBH 49 of Unit 8, located on the upper part of the yard, in close proximity to the John Brown House additions, and perhaps to the historic kitchen and outbuildings area. Unit 8 produced a large quantity of porcelain and other earthenware, including redware, whiteware, creamware, and pearlware.

These porcelain fragments were found by sifting through the collected soil from JBH 49, and thus, cannot be attributed to any one section or location within the unit. They may or may not be from the same piece of plate, cup, saucer, etc. or even from exactly the same time period.

The production range for Canton style porcelain is 1790 – 1835<sup>197</sup>, and these were most likely imported from China, where these items were produced especially for export at that time. However, Tindall asserts that “dating much Canton with certainty is almost impossible.”<sup>198</sup> Hume also attests to the difficulty of dating porcelain with no definitive markings: “for every piece of overglaze-decorated porcelain found on eighteenth-century sites there are a dozen or more ornamented only in underglaze blue, and as they are generally without reign marks they are virtually impossible to date with sufficient accuracy to be useful.”<sup>199</sup>

Canton designates porcelain shipped out of the port city of Canton, China, and is the “poorer quality of common blue-and-white China Trade wares in general.”<sup>200</sup> It became a popular American

---

<sup>197</sup> FLMNH

<sup>198</sup> Tindall, 1975.

<sup>199</sup> Hume, 1969.

<sup>200</sup> Tindall, 1975.

import after the Revolutionary War, when America began to trade with China directly, and was no longer limited by British regulations and taxes.<sup>201</sup> See below for a more complete example of Canton style porcelain.



Although the designs and decorations found on Canton and like types, such as Nanking and Fitzhugh, can be found on domestic Chinese porcelain and in Chinese art, this type of porcelain was produced almost exclusively for export.<sup>203</sup> Thus, Canton varies in quality and in color more than other types of porcelain. Some pieces contain imperfections, or are carelessly decorated by unskilled artisans and sold at a lower price.<sup>204</sup> These pieces were produced in an early type of assembly-line fashion. The color can vary from faded light blue to gray-blue to navy, and the surface texture from rough to smooth to glassy.<sup>205</sup> However, none of the porcelain pieces found on in JBH 49, or in the entirety of Unit 8 could be considered 'rough.' Whether or not this is an indication that the porcelain from this site is from the more expensive end of the Canton spectrum, and was part of the Browns' collection is up for debate.

Tindall writes that "Canton was everybody's porcelain," as it can be connected to both rich and poor homes. He notes that George Washington's Canton pieces are on display at Mount Vernon and other museums.<sup>206</sup> The loose implication here is that John Brown and George Washington were relatively friendly, as one can learn from a tour of the John Brown House Museum and the large carriage

---

<sup>201</sup> *Ibid.*

<sup>202</sup> FLMNH

<sup>203</sup> Tindall, 1975.

<sup>204</sup> *Ibid.*

<sup>205</sup> *Ibid.*

<sup>206</sup> *Ibid.*

in the woodshed. This is also an example of the kind of person who owned Canton style porcelain similar to the fragments found in JBH 49.

It is known that John Brown was an avid enthusiast of Chinese exports; many of his pieces are displayed within the museum. It is a likely probability that some of the Browns' china was used not as decoration but for food and liquid consumption, and perhaps was broken or thrown away, eventually settling in this spot in the JBH yard. The prevalence of earthenware and porcelain pieces in this part of the yard, near where the kitchen and outbuildings may have been located, speaks to the possibility that these fragments were either broken or disposed of in the food-preparation process, due to servant or slave activities. But these assertions are by no means more than educated guesses.

### **Brown Lead-Glazed Redware Fragments (Unit 8 JBH 57)**

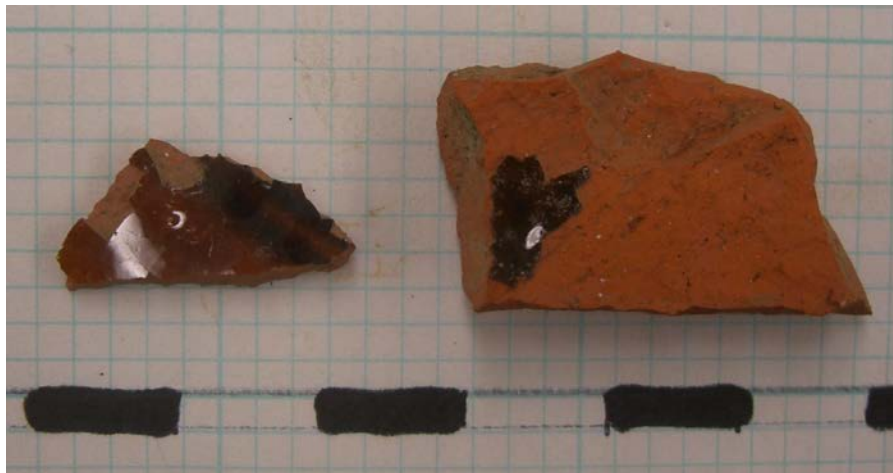

These lead-glazed redware fragments were recovered from context JBH 57 in Unit 8. As the fragments are small, when excavated their original orientation within the context was not preserved. It is possible that they came from the same plate, bowl, etc. but it is not particularly likely, considering that it is likely the soil was moved from elsewhere. Also, these were the only two shards of brown glazed redware in this context, and among the rest of the earthenware finds from Unit 8. Due to the small number of fragments of this type, it is likely that these two pieces have not always rested in this spot.

As the first American-produced form of pottery, redware dates anywhere from 1725 – present,<sup>207</sup> and can be found on many sites. Redware is the most fragile of all earthenware, as it is the most porous, and fractures easily.<sup>208</sup> Below is a manganese glazed redware pie plate with a crazing technique that dates to the late nineteenth century.

---

<sup>207</sup> Stelle, 2001.

<sup>208</sup> *Ibid.*



209

Lead glaze was applied to pottery, in order to make it impervious to liquids, as early as the twelfth century in Europe, and, though other forms of glaze existed, the various ordinary forms of earthenware have been glazed with lead up until the present.<sup>210</sup> In fact, heavy green and brown glazes were used on coarse red earthenware in mediaeval times.<sup>211</sup> Lead-glazed redware pottery was produced and intended for “ordinary use,” was sold at a low price, and was readily replaced when broken.<sup>212</sup> This perhaps speaks to the nature of the fragments at the John Brown House. Perhaps they are the remnants of a piece of redware pottery that was broken and then merely thrown away with the trash. Perhaps most of the original piece was removed from the property with the trash, and only a few fragments fell into the yard by accident.

Due to the difficulty in dating redware based on its characteristics, it exists more as a reference to what kinds of dishes and pottery were used in the John Brown House and then thrown away over the years. The fact that, in addition to porcelain, stoneware, pearlware, whiteware, and creamware found in Unit 8, these shards of redware of a particular colored glaze were found, attests to the magnitude of variety that existed within the Browns’ collection.

### **Terra Cotta Drainpipe Segment (Unit 8 JBH 57)**

---

<sup>209</sup> <[http://www.seeauctions.com/show\\_item/202745/](http://www.seeauctions.com/show_item/202745/)>.

<sup>210</sup> Barber, 1907.

<sup>211</sup> *Ibid.*

<sup>212</sup> *Ibid.*



The two terra cotta drainpipe segments (one of which is pictured from two angles) were both recovered from context JBH 57 in Unit 8. One was facing east-west and was located parallel to the south wall, 10 cm from the wall, and the other was found a similar distance from the east wall, facing north-south, parallel to the wall. Each was just above the cloth tarp, which represents the boundary between contexts JBH 57 and JBH 62. The segment by the south wall was found during normal excavations, as was left in its original orientation for some time. The segment by the east wall, however, was not uncovered until the last day of excavations. When the group peeled back the cloth tarp to reveal the gravel fill (JBH 62), the second drainpipe was inadvertently unearthed.

The end of the pipe (shown right) is 72.2 mm in width, and 87.7 mm in height, with edges approximately 25 mm thick. One side is flattened (bottom of the picture above) and the rest are rounded. This is a remnant of the mode of manufacture. The edges on either side of both segments are smooth and flat, so it is not likely that they were broken but instead were cut that way. Below is an example of like terra cotta pieces.

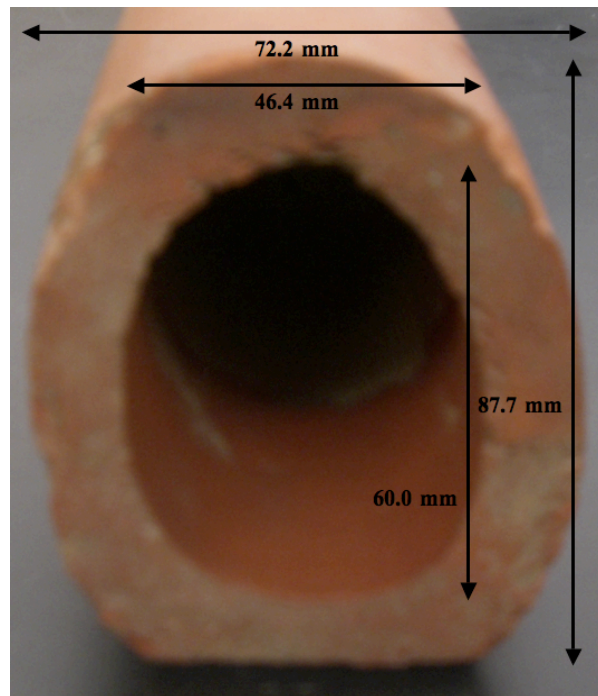





213

Examples of baked clay sewage pipes like these have been excavated from Babylonian sites and date to approximately 4000 BCE,<sup>214</sup> so these forms are not new by any means.

There are two hypotheses as to what these pipe segments were used for at the John Brown House. However, they are not mutually exclusive. The first is that they were used for some kind of drainage system for the yard. In letters, John Brown makes reference to the drainage problems he has faced in the past,<sup>215</sup> and it is likely that some kind of system had been put in place. Evidence for this lies in the prevalence of these pipes in Unit 8 context JBH 57. There were two whole segments unearthed at different locations within the unit, and another part of one protruding from the south wall (see Unit 8 summary) that was not excavated completely. The fact that these segments were not attached by any means, or that there were not more than three pieces found makes it seem likely that if there had been a water drainage system in place which utilized these actual segments, it has since been dismantled and the pieces spread out. The second hypothesis is in regard to the cloth tarp that represents the boundary between JBH 57 and JBH 62 in Unit 8. These two heavy clay pipe sections were found directly above the tarp, in positions close to its south and east edges. It is possible, then, that they were placed on the tarp as weights, while soil was deposited and the tarp was buried. This said, it is hypothesized that further excavation of the unit will unearth at least two more drainpipe segments or other relatively heavy objects that would have weighed down the north and west edges of the cloth tarp at the time of soil deposition. It is possible that both of these scenarios are true, because the drainage system could have been disturbed during the insertion of the gravel fill below the tarp, and the builders could have made use of these segments in covering the tarp.

## Works Cited

---

<sup>213</sup> <[http://www.stanglpottery.org/hill\\_drain\\_pipe.jpg](http://www.stanglpottery.org/hill_drain_pipe.jpg)>.

<sup>214</sup> <<http://www.sewerhistory.org/grfx/components/pipe-cly1.htm>>.

<sup>215</sup> Brown, 1796.



Ament, Phil. Duct Tape. Troy MI: ©1997-2007 The Great Idea Finder, 5 April 2006. Online. Available: <http://www.ideafinder.com>. 30 November 2009.

Archaeological Laboratory Artifact Codebook. University of Massachusetts Boston, Center for Cultural and Environmental History. 2004.

Barber, Edwin A. Lead Glazed Pottery, Part 1, Common Clays: Plain Glazed, Sgraffito And Slip-decorated Wares. Kessinger Publishing, 1907.

Bellis, Mary. The History of Plastics. <<http://inventors.about.com/od/pstartinventions/a/plastics.htm>>.

Brown, John. Letter to Edward Dexter. Providence, RI. 16 March 1796.

Deetz, James. In Small Things Forgotten. New York: Anchor Books, 1977.

Florida museum of natural history artifact identification guide  
Arch of college hill 2008

"Historical Archaeology at the Florida Museum of Natural History." The Florida Museum of Natural History Website. <[http://www.flmnh.ufl.edu/histarch/gallery\\_types/type\\_list.asp](http://www.flmnh.ufl.edu/histarch/gallery_types/type_list.asp)>.

Hume, Ivor N. A Guide to Artifacts of Colonial America. Pennsylvania: University of Pennsylvania Press: 1969.

Stelle, Lenville J. 2001. Archaeological Guide to Historic Artifacts of the Upper Sangamon Basin. Center For Social Research, Parkland College.  
<<http://virtual.parkland.edu/lstelle1/len/archguide/documents/arcguide.htm>>.

Tindall, Hiram. "The Canton Pattern of Chinese Export Porcelain." New York: Main Street/Universe Books, 1975.

## Cantonware Porcelan | Pipe Stem | Copper Nail/Tack

Sarah Baker

### Cantonware Fragment

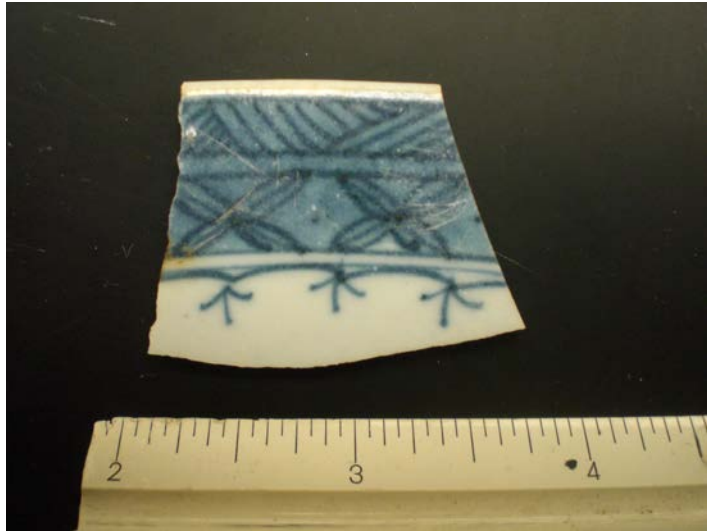

This ceramic fragment was discovered in Unit 7, Context JBH56 on November 2nd, 2009. JBH56 was on the East side of the architectural feature in that unit, and it was the deepest context reached at Unit 7. JBH56 has a tentative TPQ of about 1840. This blue-on-white fragment is one of several similarly colored pieces that were unearthed in close proximity to one another from the contexts East of the feature.

The particular fragment I have chosen appears to come from the rim of the original piece; the rim is shown at the top of the picture above. The other three edges show both smooth breaks (on the right side above) and more jagged breaks (on the left). The sherd is about 4.5 cm at its widest point, and is quite flat. The ceramic material itself is thin and white, and appears somewhat reflective because of the clear overglaze. Under this clear glaze is a blue-on-white handpainted decoration. The first layer of paint is a medium, grayish-blue color; the overlying layer shows detailing lines in darker blue. The painting includes lattice-like hatching near the smooth rim, and geometric, flower-like patterns in the second row of designs in from the ring. The third row in is just a simple, wave-like line. On the side not shown in the above picture, the fragment has very faint annular rings where the glaze has collected.

The ceramic type and decoration styles are consistent with the Florida Museum of Natural History's description of a type of Chinese porcelain called Cantonware: "White...glass-like vitreous paste...Design execution is simple, using bold brush strokes...Rim decoration on Canton Ware is of crude

blue lattice network with an inner border of wavy or scalloped lines”<sup>216</sup>. While the rim of this fragment closely corresponds with this description, it’s impossible to know whether the center illustration of the original piece matched the traditional subjects of such pieces, which included Chinese gardens and water scenes. Cantonware was manufactured in China from about 1790 to 1835; it was so cheap and was exported to America in such great quantities that during this time that this type of porcelain came to be referred to as “ballast ware”.<sup>217</sup>

Despite positively identifying this as a Cantonware fragment, determining what kind of original piece this fragment came from is difficult. Since it comes from the rim, exploring the rim curvature is one way to answer this question. The fragment’s rim edge is only about 3cm long and has a very slight curvature; having more of the rim would certainly help determine a more accurate estimate of the original piece’s dimensions. However, from this fragment, I have estimated that, if the original piece were circular, it would have had a diameter of about 70-80 cm (over two feet). It seems unlikely that the residents of the John Brown House or property would have had two-foot-wide dinner plates, so perhaps this fragment came from a serving platter, or from another type of non-circular, large dish.

Determining ownership of the original piece is about as difficult as determining its dimensions. This was a popular type of ceramic, but not the cheapest or simplest kind; the fact that it is mid-range in cost and quality contributes to this difficulty. The manufacture dates for Cantonware (1790-1835) and the TPQ for the context from which this piece emerged (1840) are similar. The time around 1840 was a time of changes on the John Brown House property. Robert Hale Ives bought the Northwestern part of the yard in 1831, near this unit, and began construction of his house. This means that the Ives family didn’t move to the property until right at the very end of the manufacture dates of Cantonware. Given this information, it’s possible that someone associated with the Brown family might have owned the original piece from which this fragment came, having bought it from some time earlier in the Cantonware manufacture range. On the other hand, a member of the Ives family might have owned this piece before moving to the Northwest corner of the property, and broken it after moving in.

How this specific piece broke off of its original and got out into the yard, though, is a mystery. It seems unlikely that a rectangular portion of a platter would snap off; something more akin to a “chip” or a triangular piece might break. However, the piece shows different kinds of breaks, so maybe it was broken more than once. The smooth break could indicate that the piece “shattered”, while the jagged break might indicate more of a “crunch” underfoot. The fact that this piece was found in the yard with so many other similar fragments perhaps identifies this as a place where refuse collected on the property,

---

<sup>216</sup> [http://www.flmnh.ufl.edu/histarch/gallery\\_types/type\\_index\\_display.asp?type\\_name=PORCELAIN,%20CANTON](http://www.flmnh.ufl.edu/histarch/gallery_types/type_index_display.asp?type_name=PORCELAIN,%20CANTON)

<sup>217</sup> *ibid.*

either by humans putting it there, or by water, snow or gravity moving the fragments down the hill away from the house.

### Pipe stem fragment



This artifact came from Unit 7, and was discovered during the sifting of soil from context JBH50 on October 26, 2009. This context lay on the Eastern side of the stacked-stone feature, numbered feature 2, and was characterized as a smooth, brown soil. JBH50 has a TPQ of 1840, though manufacture dates for several of the artifacts from this context dated much earlier than this.

This particular artifact has been identified as a fragment of a white clay pipe stem. It is one of a few pipe stem fragments discovered sitewide during the 2009 field season, but the only one found at Unit 7. There appear to be some flecks of orange-colored material on the stem, which were not removed during the careful, but vigorous brushing of the artifact-cleaning process. However, the tiny amount of this detail makes it hard to determine if the pipe was originally painted, or had been stained at some point. The artifact is about 2.8cm long. Neither end of the fragment shows a clean break; both have rough, uneven edges.

The easiest way to date pipe stem fragments in the United States is by measuring the diameter of the hole through which smoke traveled from the bowl of the pipe to the smoker's mouth. This is done by inserting drill bits through the hole; the largest bit that fits through tells the diameter. This particular fragment has a diameter of  $5/64''$ , which corresponds to a manufacture date range 1720-50.<sup>218</sup>

---

<sup>218</sup> Deetz, James. *In Small Things Forgotten*. New York City: Anchor Books/Doubleday, 1996. Print.

In his book, In Small Things Forgotten, James Deetz delves into the material history and culture associated with pipes in the United States. The first American pipes had a center diameter of about 9/64"; these pipes were short, and the custom was to gulp smoke through them, giving rise to the vernacular name for smoking: "drinking".<sup>219</sup> By 1800, the pipes had become longer and narrower, with center diameters of 4/64".<sup>220</sup> This slowed down the transferral of smoke from the pipe bowl to the smoker, giving rise to the "long contemplative smoking of pipes with which we are so familiar today".<sup>221</sup> Pipe smoking was also a communal ritual; shared pipes were continually broken down as new smokers bit off a portion of the stem before they took their turn with the pipe.

The manufacture date for this artifact falls towards the end of Deetz' date range for all pipes made; this fragment likely came from a long, thin pipe that was intended to be smoked over a long range of time, and possibly shared. This fragment was not found with or near any other similar fragments; there was no evidence to suggest that an entire pipe had been lost or discarded near this Unit. It seems more likely that this portion broke or was bitten off, perhaps while the user was working in the yard, or taking a leisurely stroll.

This pipe, in its entirety, was certainly manufactured and had likely been owned for quite a while before the TPQ of this context; the artifact was likely manufactured only as late as 1750, while JBH50 had a much later TPQ of 1840. There are three possibilities to explain this difference in dates. First, the pipe stem fragment could have been discarded or lost close to its manufacture date. In this case, gravity, water, an animal, or humans modifying the landscape of the JBH property at some point could have transported the fragment here closer to deposition of this layer. Second, the pipe could have been owned for some time, and this fragment was not discarded until after 1840, when the context was deposited.

Third, and finally, human error on the part of the 2009 JBH excavation team is entirely possible. Determining context changes in Unit 7 was difficult; the smooth, brown soil persisted throughout the unit. Also, as discussed by Ben Colburn in his Unit 7 summary, many of the artifacts found had very wide date ranges (certain kinds of nails) or were very difficult to date (bricks, architectural fragments etc.). 1840 may not be an accurate TPQ for this context, and this pipe stem fragment may not even be correctly associated with that context. Though we can say a lot about what this fragment is and how the original artifact was used, how it got to Unit 7 and any specifics about its life as a usable object remain a mystery.

---

<sup>219</sup> Deetz 28

<sup>220</sup> Deetz 27

<sup>221</sup> Deetz 28

## Copper nail/tack



This artifact was found in Unit 7, Context JBH51. JBH51 was the context West of the architectural feature found in Unit 7. This context was full of architectural rubble, and produced many artifacts. Finds from JBH51 included several varieties of mortar, brick, and nails, as well as a bunch of small, white ceramic tiles. Though many other nails came out of this and other contexts, no other nails of this specific material and dimensions emerged during the 2009 field season. This nail (or, possibly, tack) was found in the Southwestern corner of the Unit, just North of the STP from last year.

This artifact is a nail or tack of some kind, and is about 3.2 cm in length. It appears greenish in some areas, suggesting that it is made from copper. This is further corroborated by the fact that, unlike most other metal fragments and nails found this year, the nail emerged from the ground without any rust. It has a round head that appears to be machine-made, and there seems to be evidence of welding around the head. This suggests that the head was attached to the shaft after the two pieces were separately manufactured. The body of the nail is quite interesting. The top half of the shaft (connected to the head) appears to be generally round, like a cut nail. The bottom half of the shaft (ending in the tip) is more square, like a handmade nail. However, the square part tapers on two sides. This detail suggests that it was cut (machine-made), but in a fashion that was designed to make it look like an older kind of nail.<sup>222</sup> The giveaway here is that only two sides of the nail taper, whereas, with a handmade nail, all four sides would taper towards the point. As cut nails have been used in American construction since the late 1700s, and this artifact bears no maker's mark or special style, it is quite difficult to date.

---

<sup>222</sup> <http://www.glasgowsteelnail.com/nailmaking.htm>

It is also difficult to know exactly where and in what context this nail might have been used; there are several possibilities. Because of the material's durability and resistance to rust, copper nails or tacks were used in situations where the nail would be exposed to the elements. One possible location for this is in a marine setting, like a ship or dock<sup>223</sup>. This specific artifact is quite small and thin, so it seems unlikely that it could have held any large pieces of wood together. However, it could have been used to attach metal sheathing to ships. According to a mid-19<sup>th</sup> century engineer, this practice dates back to Roman use, but new patents for different combinations of sheathing metals continued to be written until as late as 1852.<sup>224</sup> Also, an 1883 *New York Times* article details the building of a fashionable yacht that involved over 6,000 copper nails in the oak construction of the ship<sup>225</sup>.

Another place where a nail or fastener like this would be exposed to the elements would be on the roof or exterior of a house; it might have been used to attach slate shingles<sup>226</sup>. As slate is an easily accessible rock in New England, slate roofs have been a long-standing building choice in the region. It is conceivable that one of the outbuildings had a slate roof. We know, for instance, that the John Brown House's woodshed, for instance, was not constructed of wood; it may have had a slate roof. However, if a nearby roof had been completely covered with slate shingles, there would have been a lot of nails associated with the processes of building and demolition; this is the only artifact of its kind that we found this year.

A third possibility for this artifact's original use is as a tack of some sort: though it is too small to hold large pieces of wood together, it might have fastened upholstery or decorative elements onto furniture pieces. Tacks were also employed in leather-working associated with horse-riding<sup>227</sup>. We know that there was a great deal of decorative furniture and a functioning stable at the John Brown House. The small size of this artifact suggests that one of these uses, or use in a marine setting, is probably more likely than its use as an architectural nail.

Though finding a TPQ for JBH51 has proved difficult, 1890 seems like a possibility. The articles mentioning copper nails in marine use come from the latter half of the 19<sup>th</sup> century. Though neither the TPQ nor this date range is definite, they do overlap. Considering the architectural rubble and other nails found in this context, perhaps this area was a demolition or refuse pile on the JBH property at some point in its history. Similar contexts were found at the Hale Ives House as at Unit 7; this layer of fill might be associated with the construction, demolition or reuse of certain architectural of the house.

---

<sup>223</sup> <http://www.sizes.com/tools/nails.htm>

<sup>224</sup> "The Fouling and Corrosion of Iron Ships", Charles F.T. Young 1867 The London Drawing Association page 37-38

<sup>225</sup> "Steam Launch for Mr. Connor's Yacht." *New York Times* 24 Jun 1883, Print.

<sup>226</sup> <http://chestofbooks.com/architecture/Building-Construction-3-1/Nailing-Slates.html>

<sup>227</sup> <http://www.jefpat.org/diagnostic/Small%20Finds/leather%20escutcheons/Web%20Pages/Difference%20between%20Tacks%20and%20leather%20ornaments.htm>



## Red Enamel Painted Porcelain Sherd | English Porcelain Sherd | Green-glazed Redware Sherd

Ben Colburn

### Red Enamel Painted Porcelain Sherd

The red hand-painted porcelain sherd was recovered from JBH45, the opening context of Unit 7. Field notes indicate that the soil in JBH45 had a fine consistency and had a Munsell value range of 5YR 2.5/1 – 10YR 2/2 (dark brown). Most finds from this context were immediately identifiable as “modern” artifacts (e.g. cigarette filter, elastic/nylon hair tie, brightly colored plastic scraps), but this sherd stood out as one of the only potentially historically significant finds from the context. For this reason, I chose to investigate the origins of this artifact as a means of determining a possible *terminus ante quem* (TAQ) for the context.

The sherd is relatively small and is approximately 1.8cm at its longest point, 1.1cm at its widest, and uniformly .19cm thick. A very small rounded edge along its perimeter indicates that it once formed part of a vessel's rim and analysis of its overall degree of curvature indicates that the complete vessel was slightly less than 3” in diameter likely a cup of sorts, possibly a teacup. The sherd bears a hand-painted red image that resembles a basic flourish motif on its convex side and a faint tan/gold border line around its circumference of curvature. There is no evidence of colored enamel underglazing on its concave side and the piece shows no evidence of having been overglazed. The lack of an overglaze and hand-painting are distinct diagnostic features that suggest that this sherd is indeed historic porcelain.



**Figure 1:** Front view of the Red Enamel Painted Porcelain Sherd

Furthermore, its brilliant white paste and the indistinguishability between paste and underglaze indicates that this porcelain was manufactured in China, not the West. According to the Florida Museum

of Natural History (FMNH) Mean Ceramic Manufacturing Dates database, Asian porcelain has been produced over a wide range of time and consequently, it is dated according to motif and glaze color. My search of porcelain images in this database revealed red to be a non-traditional color for porcelain images, especially in the absence of other colors. Of particular interest were Chinese Imari porcelain (produced 1700-1780) and Ch Ing (Qing) Polychrome Overglaze porcelain (produced 1700-1750), both of which are noted for their inclusion of hand-painted red enamel floral motifs. The FMNH notes that Ch Ing Polychrome Overglaze porcelain is essentially identical to Imari wares except they lack characteristic blue underglaze designs seen in traditional Imari porcelain designs (FMNH). Because this particular shard is so small, it is difficult to determine if its lack of blue imagery is representative of the entire vessel. Therefore, without more information, it is virtually impossible to distinguish between these two types of porcelain.

Interestingly, although the popularity of Japanese Imari endured nearly two centuries, the FMNH claims that its relative Chinese Imari ware was only popular in the American colonies for a very short period (1715-1735). Although we cannot definitively say that the sherd arrived at the John Brown House during this specific peak of popularity mentioned by the FMNH (it may have been inherited or bought well after this period even if it was less popular), this sherd can now serve as a useful piece of evidence along other finds from Stratum 1 to find the most likely time of deposition. Therefore, although it remains unclear whether the sherd is Chinese Imari or Ch Ing, it was likely imported to John Brown House during this discrete time period and is thus a highly useful temporally diagnostic find.

Unlike most other artifacts recovered from JBH45, this sherd also indicates the context's value as a historically significant sediment deposit in reconstructing life at the John Brown House. It is important to note, however, that although this sherd is unique within JBH45, it is consistent with other ceramics finds recovered from JBH50 and JBH56, both of which are also in the same indicated stratum (Stratum 1). Therefore, although this sherd is a uniquely temporally diagnostic find within JBH45, there exists already a wealth of ceramic evidence to help date Stratum 1 from other contexts.

Whether the vessel arrived at the John Brown House at the peak of its technical popularity or after, the presence of this kind of porcelain likely implicates the John Brown House as active participants in trade with China and hence, a family of high social class and economic backing. Throughout most of colonial America, porcelain can be viewed as a sign of wealth and social status and this reading of porcelain finds at the John Brown House is consistent with that logic, as is the fact that the vessel as likely used for tea, another luxury item in the colonies at this time period. In light of Mrozowski's "Individuals in Context", in addition to the myriad other indicators of wealth and trade found in Unit 7 and elsewhere in our excavation of the John Brown House, this particular sherd may implicate the John Brown House as a center for commerce in Providence and a gateway to exotic trade goods. If nothing

else, it certainly provides evidence that Providence was a city that was actively engaged in foreign ceramic trade during the 18<sup>th</sup> century (and possibly earlier).



**Figure 2:**  
A modern collector's Imari porcelain teacup, likely similar in form and decoration to the vessel from which this sherd came ("Imari Teacup")

This mercantile relationship to China is one that has been well defined, even so far as to link John Brown directly to porcelain trading in Providence. Mudge's Chinese Export Porcelain for the American Trade, 1785-1835 reveals that Providence was in fact one of the premier import centers for porcelain in America by 1785, suggesting that she likely also had a thriving porcelain trade before this time. Mudge writes that the Brown, Benson, and Ives families all collaborated to send out joint-venture ships to collect Chinese wares throughout the late 18<sup>th</sup> century (112-13). Therefore, we can understand this (likely) Imari porcelain shard to be a sign of both the John Brown House's overall wealth and ability to spend on luxury items, but also in tandem with the wealth of ceramics found in other contexts in Unit 7, a sign of the booming porcelain trade found in Providence during this time.

Lastly, this sherd may help shed some light on the functional identity of Feature 3, a feature found in the same staturum as JBH45. Although currently, no concrete theory exists to explain the existence of Feature 3, the presence of this porcelain sherd (and all other porcelain sherds found in Unit 7) suggest that Feature 3 was likely part of some lived-in outhouse. This idea corroborates the "stone wall" hypothesis, discussed in the Unit 7 Excavation Summary in Part I of this report (Ben Colburn). Again, because porcelain can be interpreted as a luxury item and hence, symbol of wealth, this same line of thought also suggests that the presumed inhabitants of this space were individuals of social status themselves. Since there is no geophysical evidence to show any part of a large outdoor structure

indicative of a lived-in outhouse in the area of Unit 7, this analysis suggests that Feature 3 may be part of a structure that served as a social space rather than a living space.

#### **WORKS CITED:**

Florida Museum of Natural History, *Mean Ceramic Manufacturing Dates*, "Porcelain, Chinese Imari."

Accessed at:

[http://www.flmnh.ufl.edu/histarch/gallery\\_types/type\\_index\\_display.asp?type\\_name=PORCELAIN, CHINESE IMARI](http://www.flmnh.ufl.edu/histarch/gallery_types/type_index_display.asp?type_name=PORCELAIN,CHINESEIMARI)

Florida Museum of Natural History, *Mean Ceramic Manufacturing Dates*, "Porcelain, Ch Ing Polychrome Overglaze."

Accessed at:

[http://www.flmnh.ufl.edu/histarch/gallery\\_types/type\\_index\\_display.asp?type\\_name=PORCELAIN, CH ING POLYCHROME OVERGLAZE](http://www.flmnh.ufl.edu/histarch/gallery_types/type_index_display.asp?type_name=PORCELAIN,CHINGPOLYCHROME)

"Imari Teacup." Accessed at [www.chinese-porcelain-art.com](http://www.chinese-porcelain-art.com)

Mrozowski, Stephen A. 2006 Individuals in context: the world of eighteenth-century Newport, in *The Archaeology of Class*

in Urban America. Cambridge: CUP, pgs. 19-36.

Mudge, Jean McClure. Chinese Export Porcelain for the American Trade, 1785-1835. London: Associated University

Presses, 1981. 112-13

## English Porcelain Saucer Sherd

This porcelain sherd was recovered from JBH50, an arbitrary context on the eastern side of Unit 7 approximately 10.5-24cmbd. Like all contexts excavated this field season in Unit 7, the soil in JBH50 had a fine consistency and had a Munsell value range of 5YR 2.5/1 – 10YR 2/2 (dark brown). This context produced almost exclusively historic finds, mainly in the form of various types of ceramic sherds, including creamware, pearlware, whiteware, and multiple types of porcelain. Amidst the different porcelain sherds, this particular sherd stood out because of a large and very noticeable brown imperfection in its paste and its clearly separate glaze-paste distinction, which is indicative of lower grade porcelain products. Because this find is inconsistent with our current conception of the Brown House residents as wealthy aristocrats, I chose to explore the history of this sherd in order to determine its origins and create a more complex history of the porcelain ceramics John Brown's family collected at the John Brown House.

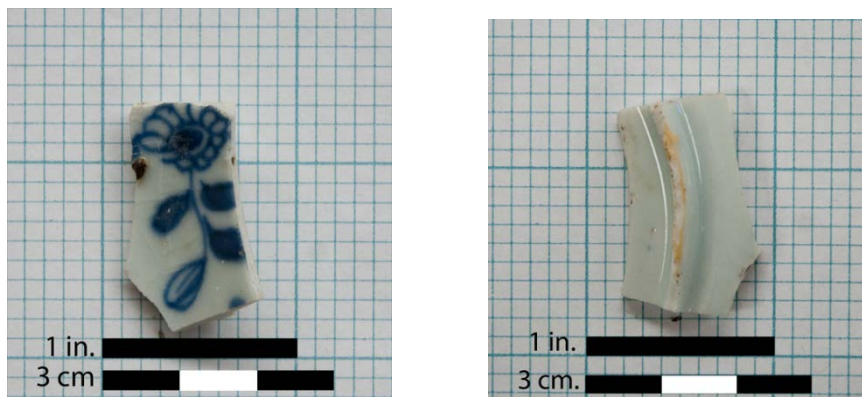

**FIGURE 1:**  
Front (left) and rear (right) view of sherd

The sherd is 3.2cm at its longest point and 1.9cm at its widest, with a variable thickness that ranges from 4.1mm (inside of curved foot) to 2.5mm (outside of curved foot). This porcelain specimen contains several diagnostic features, most noticeable of which is a curved foot that runs the full length of one side of the shard. This foot clearly indicates that the complete vessel was able to stand and therefore, the side bearing the foot faced down and the opposite side faced up. The peak of the foot is not intact, but it appears to converge to a blunt point, which according to is indicative that the complete vessel was likely a saucer. This reading is reaffirmed by analysis of the sherd's angle of elevation, which also suggests a saucer as the vessel's identity. Lastly, the foot's degree of curvature suggests the

complete vessel's base diameter to be roughly 5 inches, an approximate size for saucers in colonial America.

This sherd exhibits several characteristics which implicate its identity as a lower grade porcelain product than most others found in Statum 1 of Unit 7. First of these is the presence of multiple brown imperfections throughout the sherd, which indicate impurities in the clay and hence, use of a lower-grade clay for production. Additionally, a sideview of the sherd reveals a distinct division between paste and glaze. This clear border suggests that the clay was fired at a lower temperature than other porcelain products, which show a blurred border between paste and glaze. Additionally, the overall color of the paste is less brilliant than most porcelain whites and rougher than most paste compositions, which also suggest lower-grade clay.

Overall, these diagnostic features suggest that this piece of porcelain was not produced in the same high-quality Asian porcelain centers using premium clay and refined firing techniques that yielded most other porcelain samples recovered from Unit 7. The Florida Museum of Natural History highlights Ming Kraak porcelain as a type of porcelain that is easily identified by similar brown imperfections, but the FMNH also identifies the paste used in this type of porcelain as characteristically smooth and white, without any other mention of characteristic paste variations, the mean dates of production for Ming Kraak porcelain were 1550-1644 (FMNH), a range well before most other artifacts recovered from Unit 7.

Conversely, the FMNH entry for English soft-paste porcelain immediately notes that most porcelain products of this type exhibit a “chalky-appearing” that is “more granular than most Asian pastes (FMNH).” The entry also notes the characteristic glaze-paste divide that is indicate of low-firing temperatures as a common trait among English soft-paste porcelain samples, which also resonates with this sherd’s appearance. Given that the mean range of production for this sample was much closer to the years listed for most other ceramics finds recovered from Unit 7 (1745-1800, FMNH), it seems likely that this sherd is English soft-paste rather than Ming Kraak. Therefore, we can interpret the presence of visible brown clay imperfections as additional evidence of less refined English porcelain production standards during this time.

Using the same logic, we can interpret the floral print on the exposed surface as an attempt to replicate popular modern Chinese motifs during this time period. According to the FMNH, crude floral motifs were popular in Chinese porcelain exports over a wide range of time, ranging from 1644-1912 in Ch Ing (Qing) blue on white porcelain (FMNH). Therefore, although this particular motif is not temporally diagnostic, it helps further indicate the distinctly Chinese source of inspiration for this vessel and English soft-paste porcelain in general.



**FIGURE 2:**

A complete English porcelain saucer (pictured here with a smaller tea bowl) that likely represents the vessel from which this sherd came in its original state (Steppeshill Farm).

However, the question remains: why would the John Brown House have imported such a low-grade sample of porcelain when it had such easy access to so many more refined samples through its myriad trade connections (Mudge)? According to the Metropolitan Museum of Art, the first major European soft-paste porcelain factory opened at St. Cloud in 1702 and produced a blue-painted variety of European porcelain that, despite its differences from Asian porcelain, is actually quite revered. W.B. Honey says in *European Ceramic Art* (1952), that St. Cloud porcelain, “is one of the most distinct and attractive of porcelains, and not the least part of its charm lies in the quality of the material itself. It is rarely of a pure white, but the warm yellowish or ivory tone of the best wares of the period is sympathetic and by no means a shortcoming; and while actually very soft and glassy, it has a firm texture unlike any other. The glaze often shows a fine satin-like pitting of the surface that helps to distinguish it from the brilliant shiny glaze of Mennecy, which is otherwise similar. The heavy build of the pieces is also characteristic and is saved from clumsiness by a finer sense of mass, revealed in the subtly graduated thickness of wall and a delicate shaping of edges (495).”

This description matches the aberrations described above insofar as the paste color is not as white as most Asian porcelains and shows a graduation of thicknesses that, according to our assessment that it is a saucer, would follow the functional aesthetics of the St. Cloud factory. No pitting is immediately visible in this specimen, so it is not possible to conclude its identity as such; however, the Metropolitan Museum of Art indicates that it was only after one major European porcelain factory moved to Sèvres, France in 1756 that a finer grade of soft-paste porcelain was developed in European export products. Before this time, only lower-grade porcelain products were freely available from



European factories (Metropolitan Museum of Art). Therefore, it is possible that this specimen was one such piece of porcelain that was bought before European technologies improved and hence, was superior when it was bought despite changes in the market.

This hypothesis would fit well with our understanding of the John Brown House residents as wealthy aristocrats interested in investing in new technologies and luxury products, as indicated by their interest in Asian porcelain. Therefore, if European porcelain products were new at the time that this vessel was purchased, Brown House investors would likely have interpreted its purchase as an investment in a new cultural trend rather than a refined product like other Brown House porcelain finds imported from Asia.

This is also helpful information in terms of diagnosing the temporal range of Stratum 1. Whereas the manufacturing dates for most finds in JBH50 and JBH56 are restricted to the 18<sup>th</sup> century, if this find were indeed early European porcelain, we could limit the date range for deposition to the first half of that century (pre-1756) based on the assumption that the Brown House would not purchase such a piece of porcelain if more refined technology were already available.

#### **WORKS CITED:**

Florida Museum of Natural History, *Mean Ceramic Manufacturing Dates*, "Porcelain, Kraak." Accessed at:

[http://www.flmnh.ufl.edu/histarch/gallery\\_types/type\\_index\\_display.asp?type\\_name=PORCELAIN, KRAAK](http://www.flmnh.ufl.edu/histarch/gallery_types/type_index_display.asp?type_name=PORCELAIN,KRAAK)

Florida Museum of Natural History, *Mean Ceramic Manufacturing Dates*, "English Soft Paste."

Accessed at:

[http://www.flmnh.ufl.edu/histarch/gallery\\_types/type\\_index\\_display.asp?type\\_name=PORCELAIN, ENGLISH SOFT PASTE](http://www.flmnh.ufl.edu/histarch/gallery_types/type_index_display.asp?type_name=PORCELAIN,ENGLISH%20SOFT%20PASTE)

Florida Museum of Natural History, *Mean Ceramic Manufacturing Dates*, "Ch Ing Blue on White."

Accessed at:

[http://www.flmnh.ufl.edu/histarch/gallery\\_types/type\\_index\\_display.asp?type\\_name=PORCELAIN, CH ING BLUE ON WHITE](http://www.flmnh.ufl.edu/histarch/gallery_types/type_index_display.asp?type_name=PORCELAIN,CH%20ING%20BLUE%20ON%20WHITE)

Honey, W.B., Old English Porcelain, a Handbook for Collectors. Faber and Faber, 1952. 495.

Metropolitan Museum of Art. "Sèvres Porcelain in the Nineteenth Century." Heilbrunn Timeline of Art

History. Accessed at: [http://www.metmuseum.org/toah/hd/sevr/hd\\_sevr.htm](http://www.metmuseum.org/toah/hd/sevr/hd_sevr.htm)

Steppeshill Farm Auction House. "Early Worcester Porcelain Teabowl and Saucer."

### **Green-Glazed Redware Sherd**

This redware sherd was recovered from JBH45, the opening context of Unit 7. Field notes indicate that the soil in JBH45 had a fine consistency and had a Munsell value range of 5YR 2.5/1 – 10YR 2/2 (dark brown). Most finds from this context were immediately identifiable as “modern” artifacts (e.g. cigarette filter, elastic/nylon hair tie, brightly colored plastic scraps), but this sherd stood out as one of the only potentially historically significant finds from the context. It appears to be related to the green lead glazed redware finds in JBH23 (2008) and hence, represents a significant ceramic presence in the John Brown House estate. For this reason, I chose to investigate the origins of this artifact as a means of determining a possible *terminus ante quem* (TAQ) for the context.

This redware sherd is approximately 3cm at its longest point and 2.5cm at its widest. The radius of curvature is quite subtle in this relatively small shard, so it is virtually impossible to accurately extrapolate the projected diameter of the complete vessel. It appears that both sides were completely glazed, one with a matte apple-green lead glaze and the other with a glossy medium-brown lead glaze. Because one surface has lost most of its glaze, there is only one very small point at which it is possible to accurately determine the thickness of the vessel (4.7mm) and we cannot determine if this thickness changes at all throughout the vessel. Beyond being red, the clay used for this vessel also contained a significant amount of small pebbles within it, indicating a relatively unrefined source. There were no functionally diagnostic features that indicate the exact identity of this vessel and hence, its precise original form is unknown.

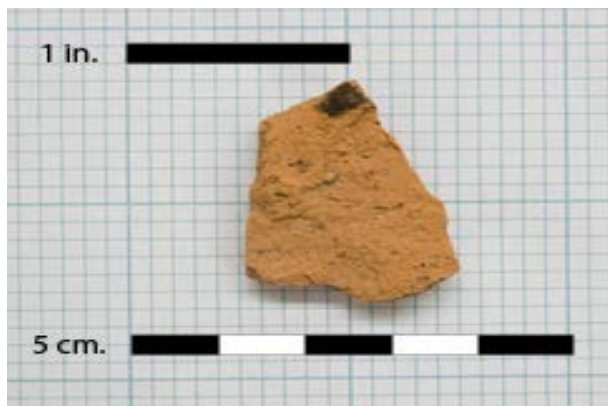
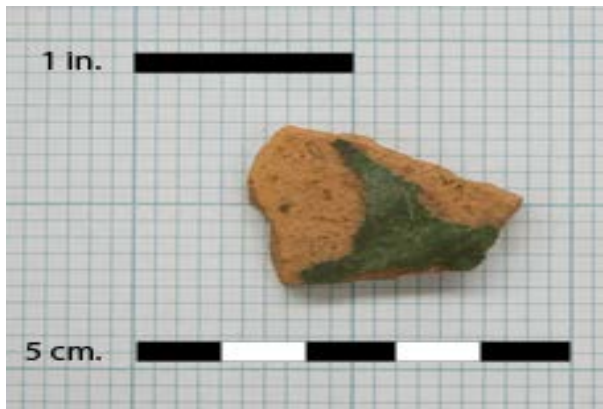

**Figure 1:**  
Outside (left) and inside (right) views of the Green-Glazed Redware Sherd

Turnbaugh writes on redware is “the most commonly ceramic found around the globe (469)”and consequently, the ubiquitous presence of similarly structured vessels and production techniques means that oftentimes, the only means of distinguishing between specific production sites is chemical analysis (471). Despite this ambiguity of vessel production, Hume writes in [A Guide to the Artifacts of Colonial America](#) that “Body colors varied from buff coated with an apple-green glaze, to red covered with a purplish-brown tortoise-shell lead glaze (146)” and that these decorative traits can often be linked to localized redware production cultures.

Redwares are part of a general family of early colonial ceramics known as coarse earthenwares, so named because the material of production itself is more porous than later technologies and fired at a lower temperature (900-1200°C). Because the firing temperature is so low, lead oxide flux was commonly used to lower the melting temperature of the glaze and hence, in addition to their paste color, redwares are also known for their characteristic use of lead glazes. Additionally, the The Florida Museum of Natural History (FMNH) indicates that small quartz pebbles (like those seen in our fragment) were often added to clay to temper it and reduce warping during the firing process.

Most sources agree that redware vessels were primarily utilitarian and often used to display or store food. This is supported by the fact that most redware vessels are glazed inside and out (like this sherd), suggesting the need to protect against the porous nature of redwares for use with edible contents. Consequently, we can likely assume that the vessel this sherd came from served a similar purpose. Several sources report England as the most common origin of redware found in colonial America during the 18<sup>th</sup> century, though other authors make a clear case that the popularity of domestically-produced redwares endured into this century (Stiles). The FMNH lists dates of production for redware in America between 1700-1700 it was only when refined earthenwares arrived in the colonies around 1770 that redware popularity ultimately waned in deference to superior material technologies.

Interestingly, the apple green color of the glaze on this particular shard is documented to predate FMNH estimates of redware use in the colonies. Although lead glazes in general were commonly used throughout the cited range of production, this particular glaze was colored using zinc oxide, a technology that the FMNH dates as being used from 1490-1650). Deetz further constricts this timeframe by indicating that colonists did not begin producing this unique type of ware until 1620 (70), but Providence was not founded until 1635, suggesting a new timeframe of production from 1635-1650.

The shortcomings of ceramic dating must be given special consideration in the case of redware due to its lack of distinguishing characteristics, which might confound dating efforts (Nuding). Given the particularly restricted timeframe for production cited above, we must consider the possibility of William Adams's "Heirloom effect." Adams argues that "The manufacturing date fact cannot be equated with an artifact's use date (Adams 41, as cited on Nuding 215, JBH 2008 Report)," and given the seeming consistency among other artifacts suggesting deposition sometime in the early- to mid-18<sup>th</sup> century, it is likely that this artifact was preserved within the Brown estate for several decades before it was ultimately discarded. Hume presents two such examples of late-discarded apple-green glazed redware vessels in his book, one c. 1700 (146) and the other discarded in the late 17<sup>th</sup> century (77), though it is not possible to directly correlate these dates to the dates in which this vessel was deposited.

Redware has a relatively variable lifetime, depending on the thickness of the vessel. Whereas redware is traditionally thought of as a utilitarian vessel, only those vessels with thicker walls are likely to survive well beyond their date of production. In the case of this sherd, the wall is relatively thin, making its vessel more susceptible to damage than some other redwares with thicker walls. Therefore, the likelihood that it survived from production from the mid-17<sup>th</sup> century until a time of deposition hypothesized to be within the 19<sup>th</sup> century (as indicated by the presence of painted pearlware) is suspect.

It is entirely possible that this shard may have survived that long, though this longevity calls into question its functionality as a utilitarian vessel. It is perhaps more likely that given its lifespan this

particular vessel was treated as decorative art or else a non-functional heirloom in the John Brown estate. That is not to say that it might not have been originally produced as a utilitarian vessel, but it is unlikely to have been used as such, given that it has such thin walls survived to deposition in the 19<sup>th</sup> century. Given the high class status of the Brown family, it seems unlikely that such an old vessel would have been purchased beyond its date of production when the family could so easily afford more modern wares. Therefore, we are left with the likely hypothesis that it was purchased during the discrete period of this vessel type's production and retained via bequests until a time of later deposition. Consequently, this artifact is not of use in the establishment of a TAQ for JBH45 because external forces of artifact retention are likely responsible for its deposition in Unit 7.

If this sherd were indeed a special artifact from the John Brown House ceramics collection, then its location in Unit 7 makes the identity of Feature 3 all the more mysterious. As has been the case with all ceramics finds in Unit 7, we have as of yet been unable to determine why such precious goods would have been located in such a remote location where no outhouse is explicitly documented to have existed if the "stone wall" hypothesis is indeed correct. Additionally, the continued presence of such finds makes the "paved path" hypothesis discussed in Part I of this report (see Unit 7 Excavation Summary by Ben Colburn) unlikely, especially given the special status that the vessel this sherd came from may have had in the Brown household.

#### **WORKS CITED:**

Adams, William Hampton. "Dating Historical Sites: the Importance of Understanding Time Lag in the Acquisition, Curation,

Use, and Disposal of Artifacts." *Historical Archaeology*, 2003.

Florida Museum of Natural History, search "background color = GREEN and glaze = LEAD GLAZED"  
Accessed 1 December  
2009.

Hume, Ivor Noel. *A Guide to Artifacts of Colonial America*. Philadelphia: Random House, 1969.

James Deetz, *In Small Things Forgotten*, 1977, p. 70

Nuding, Elise. *John Brown House Archaeological Report 2008*. Accessed at:

<http://proteus.brown.edu/archaeologyofcollegehill/Home>

Stiles, Helen E. *Pottery in the United States*. New York: Dutton, 1941.

Turnbaugh, Sarah Peabody. *Domestic Pottery of the Northeastern United States 1625-1850*, Academic Press, 1985

---

---